

PLATEAUX DE DOUCHE

PIATTI DI DOCCIA

PLATOS DE DUCHA

RESIN SHOWER TRAY

C A T A L O G U E
2 0 2 0





DAYA SANI-WARE MFY. LTD, was established in Shantou (China) in 1995, and set up a plant in Huaian (China) in 2017. With unremitting efforts in the past 24 years, we have attracted customers from 26 countries, securing DAYA with a global reputation in the fields of sanitary, including shower enclosures, poly marble shower trays, resin wash basins.



**24
years**



**40,000 m²
factory area**



**12,000
pcs/month**



**26
countries**



Covering an area of 40,000 square meters with the latest technical equipment, based on the CE certification and the production capacity of 20,000 pieces per month, we can supply the prompt delivery to our customers from all the European market.

As a dynamic company we exert ourselves for providing a tailor-made manufacturing service from design concept through to cost-effective production. With sharp market insight, DAYA can follow the latest industrial trend, create the good products which can fit the current markets. As a supplier, we have the opportunity to create our own product lines as well as engaging in the projects for the third party.

To design and manufacture top quality products which offer choices for all markets. DAYA, a professional manufacturer which devotes to technology, innovation and high quality. We look forward to cooperating with you!

SERIE F
RESIN SHOWER TRAY



SERIE I
RESIN SHOWER TRAY



SERIE M
RESIN SHOWER TRAY

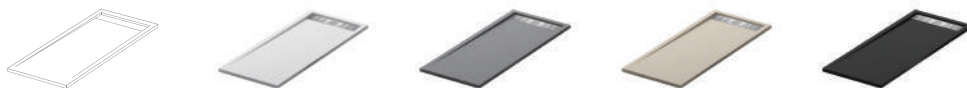

SERIE K
RESIN SHOWER TRAY



SERIE L
RESIN SHOWER TRAY



SERIE G
FIBER SHOWER TRAY



INSTALLATIONS



APPLICATIONS

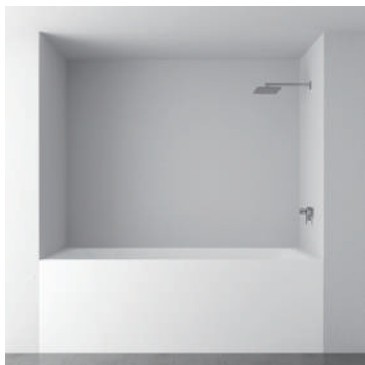

MATERIAL OF PRODUCT

MATERIAL COMPONENTS:

1 Gelcoat	3%
2 Unsaturated polyester resin	23%
3 Calcium carbonate	72%
4 Catalyst	1%
5 Curing agent	1%

FEATURES AND FUNCTIONS



Mass coloration



Anti-slip



Include covers



Include drainers



Cuttable



Antibacterial



Waterproof



Supports repairs



Ecological material



Optional colours



5 years guarantee



Easy to clean

PRODUCT ACCESSORIES



DAYA's shower tray includes main product - shower tray,
accessories - cover+drainer+ instruction guide

CERTIFICATE



All our products have CE certificate to guarantee the high quality and meet international standard.
We produce all products in accordance with the international safety standard, including the raw material controlling and the production process.

SERIE F

RESIN SHOWER TRAY

Serie F is a shower tray with simple design which provides the bathroom with a natural, comfortable and minimalist atmosphere. A shower tray with classical lines characterised by being extremely flat. Suitable for any bathroom surface, as it can be cut on any of its sides.





SERIE F

RESIN SHOWER TRAY

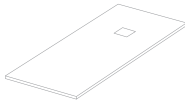

Slate Stone
Texture

For other sizes,
please contact with
the sales department

MEASURES

	70	80	90
80		●	
90	●		●
100	●	●	●
110	●	●	●
120	●	●	●
130	●	●	●
140	●	●	●
150	●	●	●
160	●	●	●
170	●	●	●
180	●	●	●
190	●	●	●
200	●	●	●

Measurements in cm

Thickness is 2.5cm for the width of 70cm and 80cm
Thickness is 2.5cm for the width of 90cm,
by the length under 120cm (include 120cm)
Thickness is 3.0cm for the width of 90cm,
by the length over 120cm.

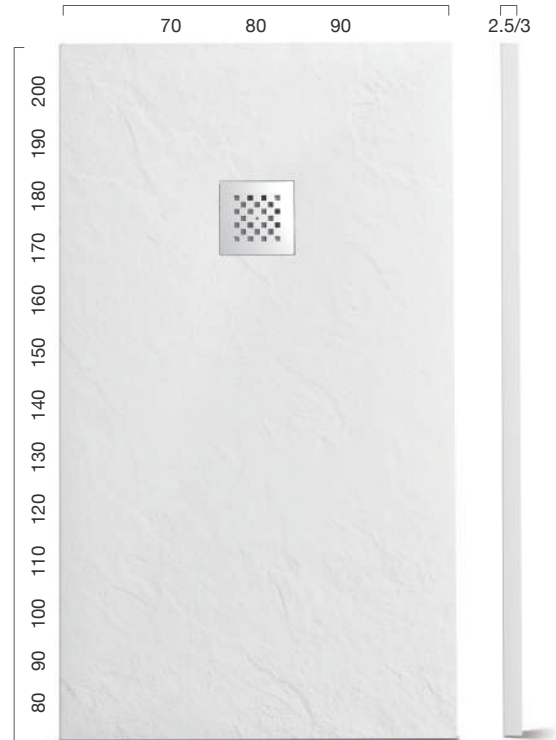

TEXTURES & COLORS



WHITE



LIGHT GRAY



BEIGE



DARK GRAY

For other colors,
please contact with the sales department

COVER



cover 1



cover 2



cover 4



cover 5

DRAINER



DY-11



DY-16



DY-132

DRAIN POSITION

A	C
70cm	35cm
80cm	40cm
90cm	45cm

B	D
$\geq 150\text{cm}$	43cm
$\leq 140\text{cm}$	31cm



SERIE I

RESIN SHOWER TRAY

Following the lines of the natural model, this series is suited to any situation as a result of its custom-made frame, which provides it with greater watertightness. Its adaptable sizes will blend into any environment.

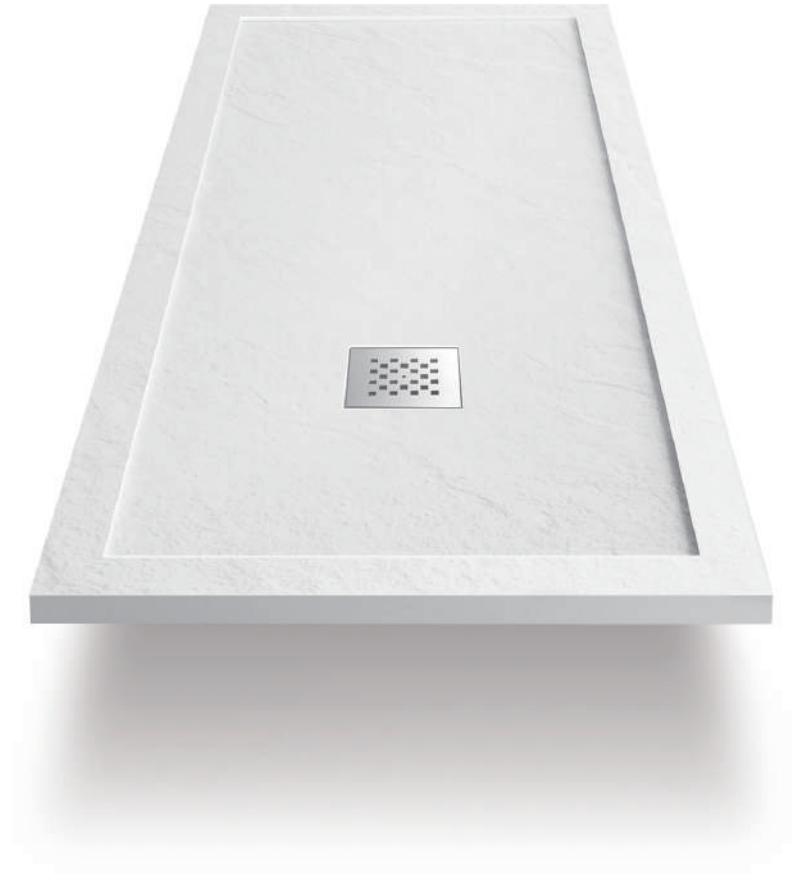



SERIE I

RESIN SHOWER TRAY

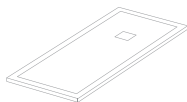

Slate Stone
Texture

For other sizes,
please contact with
the sales department

MEASURES

	70	80
80		●
90	●	
100	●	●
110	●	●
120	●	●
130	●	●
140	●	●
150	●	●
160	●	●
170	●	●
180	●	●

Measurements in cm
Thickness: 3.3cm

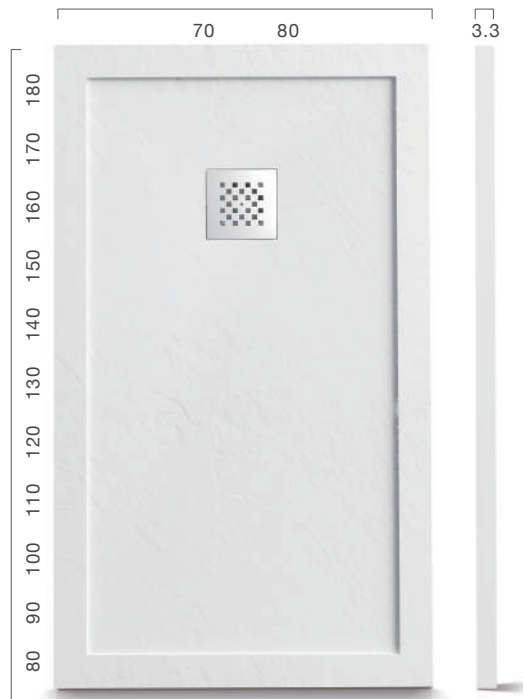

TEXTURES & COLORS



WHITE

LIGHT GRAY

BEIGE

DARK GRAY

For other colors,
please contact with the sales department

COVER

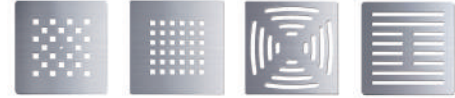

cover 1

cover 2

cover 4

cover 5

DRAINER



DY-11

DY-16

DY-132

DRAIN POSITION

A	C	B	D
70cm	35cm	$\geq 150\text{cm}$	43cm
80cm	40cm	$\leq 140\text{cm}$	31cm



SERIE M

RESIN SHOWER TRAY

With strong and well-defined lines, serie M perfectly suits the uniqueness of your bathroom, making the space more sophisticated as a result of the dynamic nature of its design.





SERIE M

RESIN SHOWER TRAY

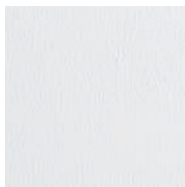
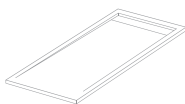

Wooden
Texture

For other sizes,
please contact with
the sales department

MEASURES

	70	80	90
80		●	
90			●
100	●	●	
110	●	●	
120	●	●	
130	●	●	
140	●	●	
150	●	●	
160	●	●	
170	●	●	
180	●	●	

Measurements in cm

Thickness is 2.5cm for the length under 120cm
(include 120cm)

Thickness is 3.0cm for the length
from 130cm to 160cm

Thickness is 3.3cm for the length over 170cm

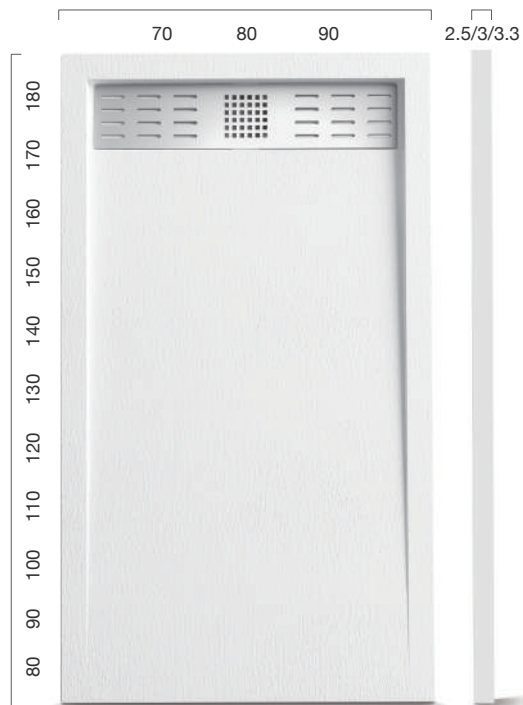

TEXTURES & COLORS



WHITE



LIGHT GRAY



BEIGE



DARK GRAY

For other colors,
please contact with the sales department

COVER



cover 7

DRAINER



DY-11

DY-16

DY-132

DRAIN POSITION

A	C	D
70cm	35cm	11.6cm
80cm	40cm	
90cm	45cm	



SERIE K

RESIN SHOWER TRAY

At the request of market trends, this seires is presented as a new version of the conventional shower tray due to its hidden drain, achieving an up-to-date minimalism bathroom.





SERIE K

RESIN SHOWER TRAY

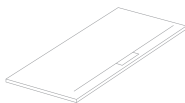

Sand
Texture

For other sizes,
please contact with
the sales department

MEASURES

	70	80
100	●	●
110	●	●
120	●	●
130	●	●
140	●	●
150	●	●
160	●	●
170	●	●
180	●	●

Measurements in cm
Thickness: 2.5cm

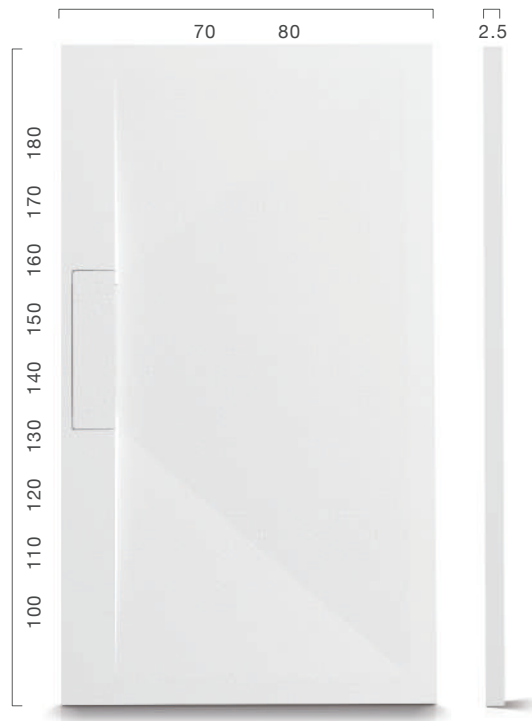

TEXTURES & COLORS

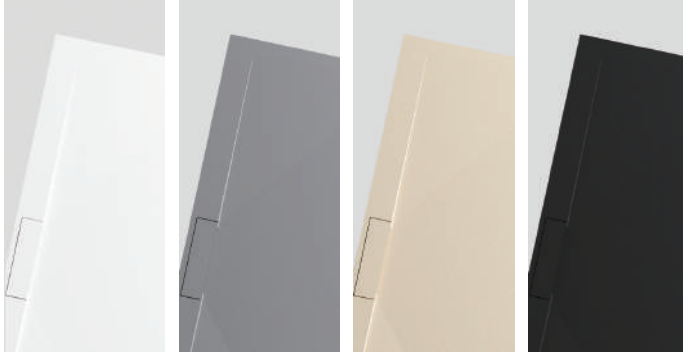

WHITE



LIGHT GRAY



BEIGE



DARK GRAY

For other colors,
please contact with the sales department

COVER

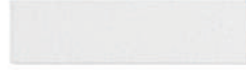

DRAINER



DY-11



DY-21

DRAIN POSITION

A	C	D
70cm	63.9cm	30cm
80cm	73.9cm	

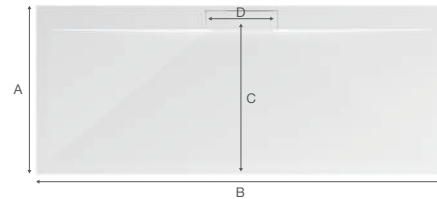

SERIE L

RESIN SHOWER TRAY

This series is characterised by its special tilt, allowing easy and rapid drainage. The position of the grill and the frame situated at the front, giving it a modern and exclusive appearance.





SERIE L

RESIN SHOWER TRAY

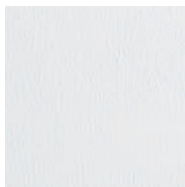
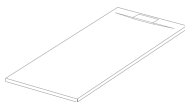

Wooden
Texture

For other sizes,
please contact with
the sales department

MEASURES

	70	80
100	●	●
110	●	●
120	●	●
130	●	●
140	●	●
150	●	●
160	●	●
170	●	●
180	●	●

Measurements in cm
Thickness: 2.5cm

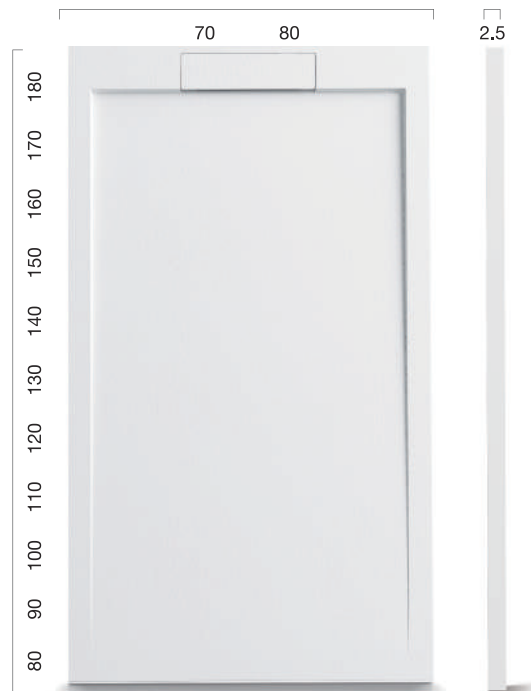

TEXTURES & COLORS



WHITE

LIGHT GRAY

BEIGE

DARK GRAY

For other colors,
please contact with the sales department

COVER



DRAINER



DY-11

DRAIN POSITION

A	C	D
70cm	35cm	6.1cm
80cm	40cm	





SERIE G FIBER
SHOWER TRAY



Fiberglass
Material



FEATURE

This product is a kind of new material, which is made of a compounds of fiber glass and reinforced material with gelcoat on the surface. One of the lightest shower trays on the market with excellent bearing effect, stable performance and long usage time.



Single Operating



Higer Solidhardness



Better Utilization

Weight / kg

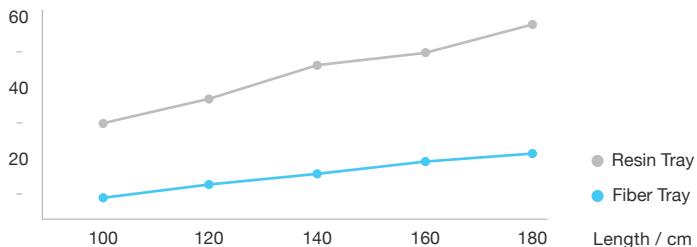

THEORETICAL WEIGHT

	100cm	110cm	120cm	130cm	140cm	150cm	160cm	170cm	180cm
70cm	14.4kg	15.8kg	17.3kg	18.8kg	20.3kg	21.6kg	23.3kg	24.2kg	25.8kg
80cm	16.3kg	17.9kg	19.5kg	21.0kg	22.9kg	24.5kg	26.2kg	26.9kg	29.3kg

SERIE G

FIBERGLASS SHOWER TRAY

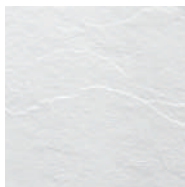
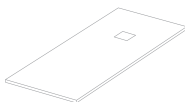

Slate Stone
Texture

For other sizes,
please contact with
the sales department

MEASURES

	70	80
100	●	●
110	●	●
120	●	●
130	●	●
140	●	●
150	●	●
160	●	●
170	●	●
180	●	●

Measurements in cm
Thickness: 3.5cm

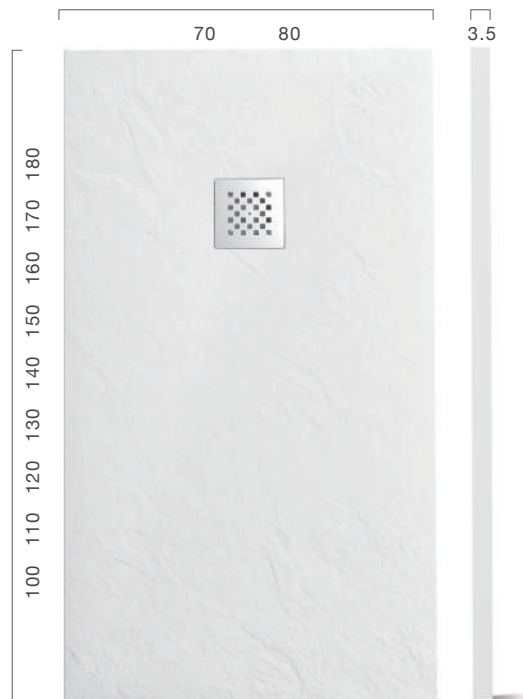

TEXTURES & COLORS



WHITE

For other colors,
please contact with the sales department

COVER

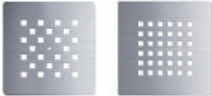

cover 1 cover 2

DRAINER



DY-11 DY-16 DY-132

DRAIN POSITION

A	C	B	D
70cm	35cm	≥150cm	43cm
80cm	40cm	≤140cm	31cm



SHOWER TRAY DRAINER

Four different designs to choose from,
to determine the best allocation.



DY-132

SHOWER TRAY
DRAINER



SERIE F SERIE I SERIE M SERIE G



Flow rate: $\geq 0.43\text{l/s}$
Measurements in mm

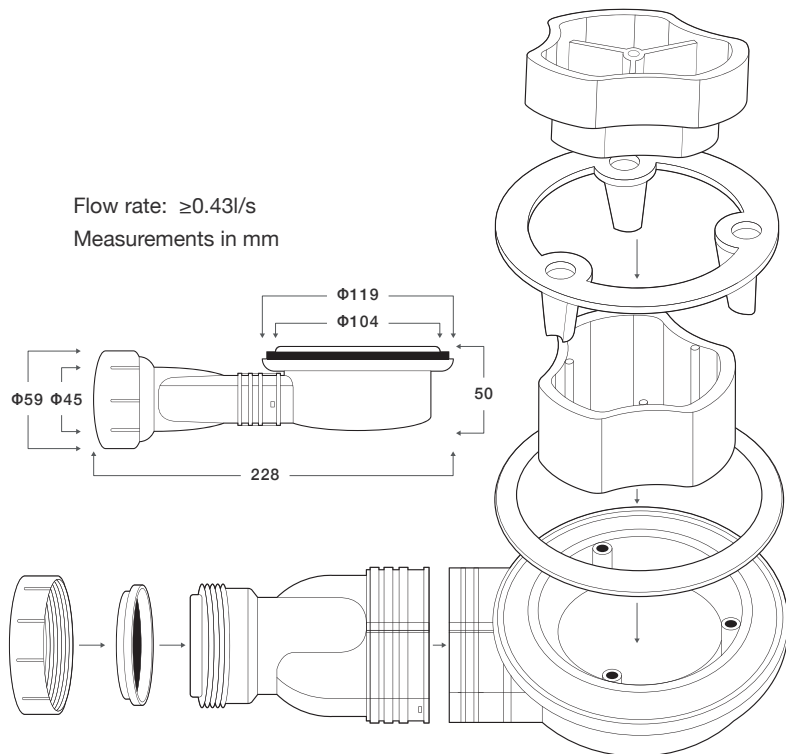
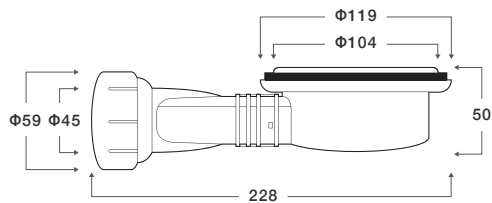

DY-11

SHOWER TRAY
DRAINER



SERIE F SERIE I SERIE M SERIE G



Flow rate: $\geq 0.42\text{l/s}$
Measurements in mm

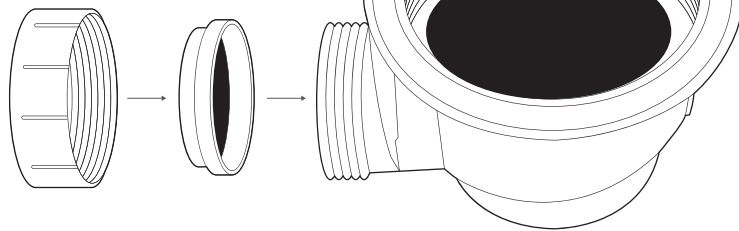
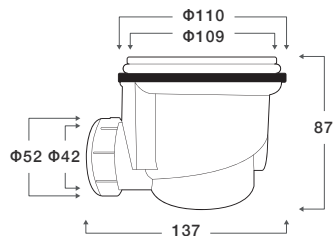

DY-16

SHOWER TRAY
DRAINER



SERIE F SERIE I SERIE M SERIE G

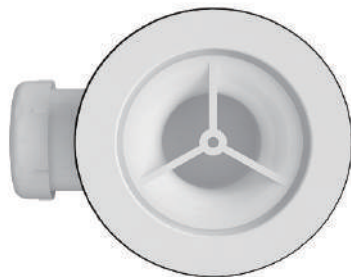

Flow rate: $\geq 0.43\text{ l/s}$
Measurements in mm

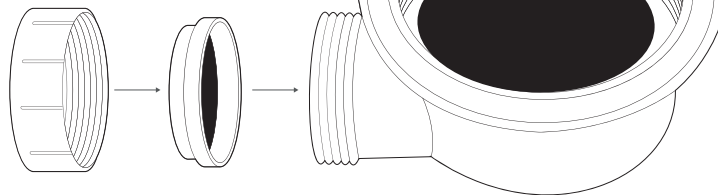
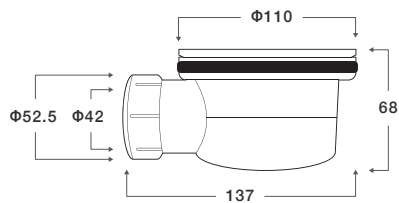

DY-12

SHOWER TRAY DRAINER

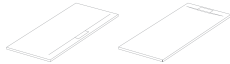

SERIE K SERIE L

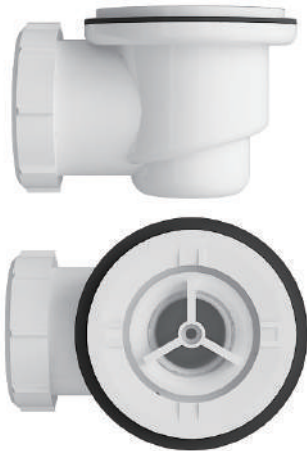

Flow rate: $\geq 0.4\text{l/s}$
Measurements in mm

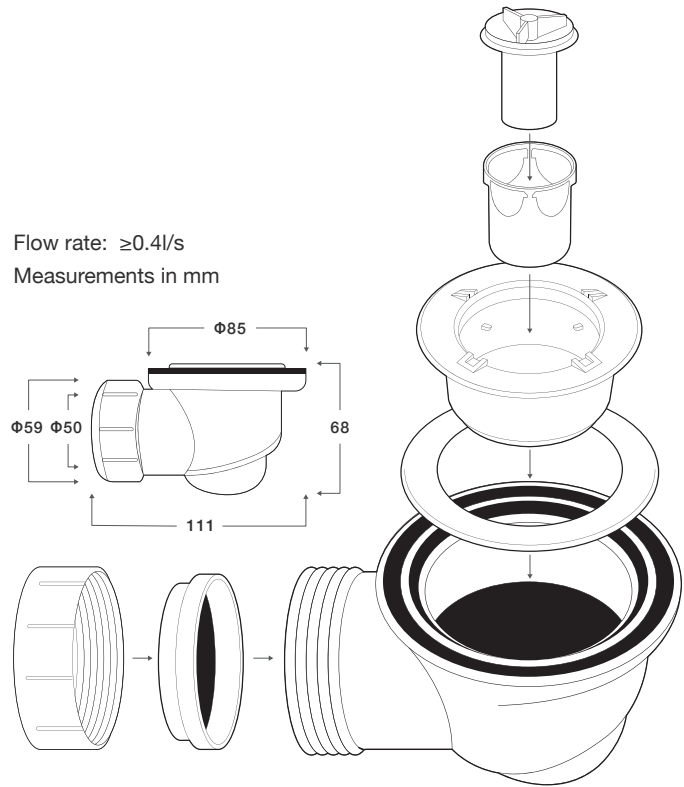
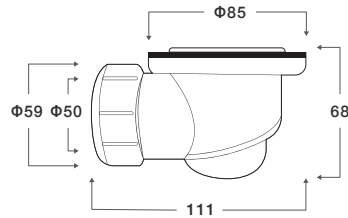

DY-21

SHOWER TRAY DRAINER



K SERIE



L SERIE



Flow rate: $\geq 0.43\text{l/s}$
Measurements in mm

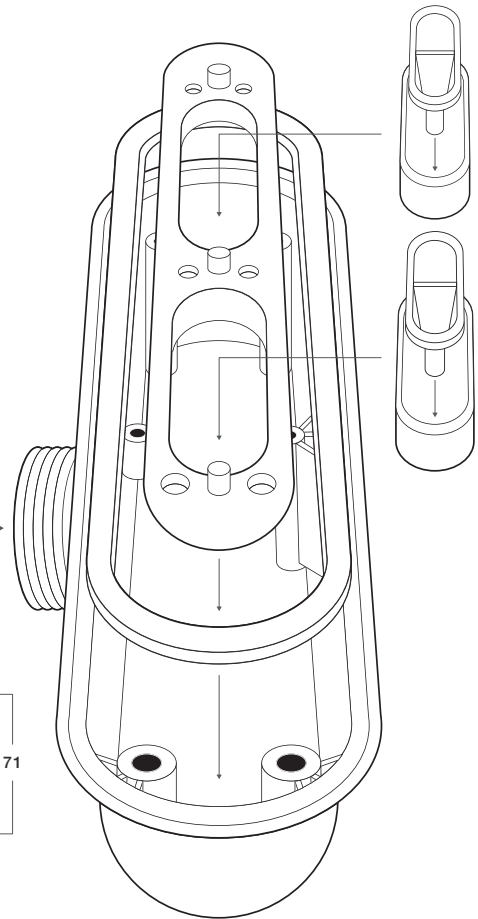
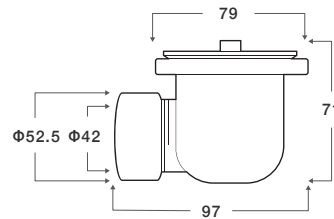

INSTALLATION INSTRUCTION

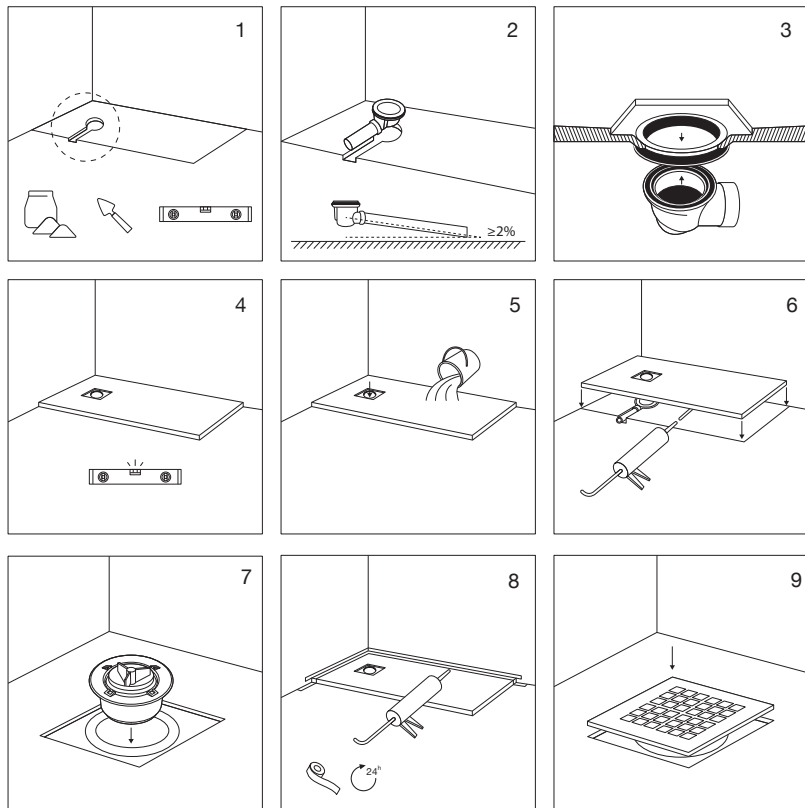

Remove the protective covering in the area around the plug hole, and on the sides where the tray will meet the wall. Make sure the correct fittings are attached to the top of the waste pipe and secure the waste fittings around the plughole of the shower tray.

If you are installing the tray directly onto the floor, line it up over the waste trap to make sure it fits into place. Outline the edge of the tray with your pencil – this will help you to determine where to spread the mortar.







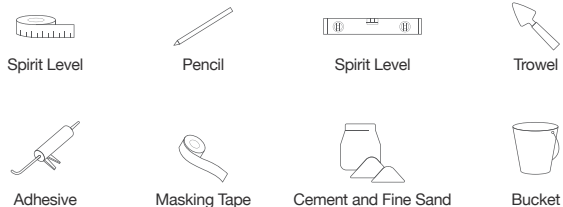

If your shower tray kit included a wall sealant strip, secure it to the tray at the sides where it meets the wall. If not, use your caulking gun and apply a thin layer of silicone to create a watertight seal along the edge of the tray.

Remove the rest of the plastic covering and secure the waste outlet to the trap, according to the manufacturer guidelines. This may be something you can simply tighten into place from above, or you may have to navigate from beneath the tray in order to secure the fittings.









If your shower tray kit included a wall sealant strip, secure it to the tray at the sides where it meets the wall. If not, use your caulking gun and apply a thin layer of silicone to create a watertight seal along the edge of the tray.



TECHNICAL SPECIFICATIONS

	CHARACTERISTIC OR ATTRIBUTE	DATA	OBSERVATION
	Mass coloration	✓	Facilitates the repair and minimises the appearance of small surface flaws.
	Cuttable	✓	Able to be adapted to the available space.
	Ecological material	✓	Composite material. 90% of the components are resin and mineral fillers.
	Anti-slip	✓	Anti-slip level according to Standard UNE-EN 14688.
	Antibacterial	✓	Made antibacterial by the Gelcoat.
	Optional colours	✓	Possibility of manufacturing with the optional color in catalogue.
	Include covers	✓	DAYA's shower trays include covers.
	Include drainers	✓	DAYA's shower trays include drainers.
	Supports repairs	✓	This material allows for the repair of small bumps and imperfections.

TECHNICAL SPECIFICATIONS

	CHARACTERISTIC OR ATTRIBUTE	DATA	OBSERVATION
	Cleaning	✓	Easy to clean.
	Dimensional tolerance threshold	✓	Our material offers great dimensional stability.
	Resistance to wear and tear	✓	Highly durable material, barcol hardness 57.
	Waterproof	<0.01%	The absorption of the shower trays less than 0.01%.
	Quality guarantee	5 years	5 years guarantee.
	Drainer certificate	✓	Certificated by EN 274-1:2002.
	Gelcoat	1mm	Extremely hard surface. Hot-melt mould coating. Not painted.
	Cover material	✓	Covers are produced by 304 stainless steel.
	Pallet	plywood	Packed with plywood pallet (no fumigation required).

BATHROOM PANEL

The lining panels are the ideal solution for replacing a bathtub with a shower tray, as they are the perfect accessory for giving the bathroom a natural appearance.



PANEL

BATHROOM PANEL

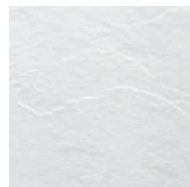
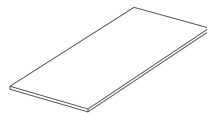

Slate Stone
Texture

For other sizes,
please contact with
the sales department

MEASURES

	200
50	●
60	●
70	●
80	●
90	●

Measurements in cm
Thickness: 2.2cm-4cm





INSTALLATION INSTRUCTION

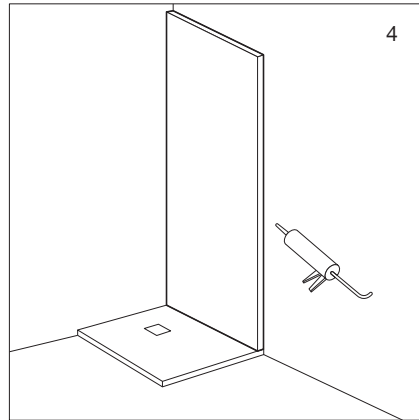
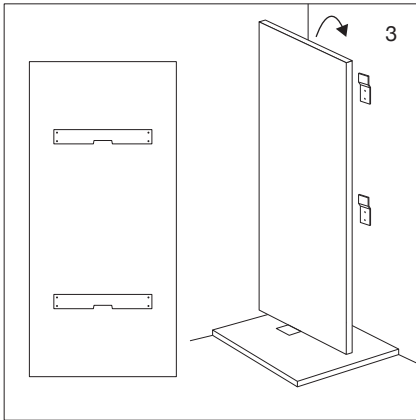
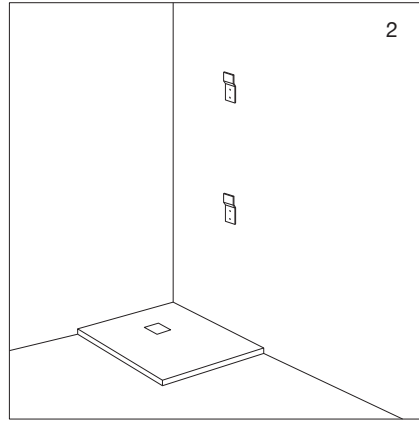
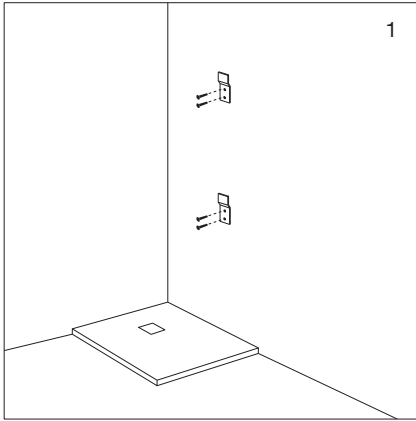

Measure out where the short hooks will be positioned and drill four installation holes $\Phi 6$. Fill the expansion shells and install two short hooks on the wall.

Aim the long hooks which are fixed in the back of wall board, toward the short hooks, and put in position. After confirmed the installation is perfect, use glass glue seal.



Spirit Level

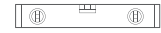

Spirit Level



Adhesive

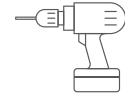

Electric Drill

PRODUCT PACKAGE

Step 1

Strict inspection by QC dept., then clean and deliver to packaging dept. for packing.



Step 2

With PP bag to protect first, then EPE surround the tray. The COVER will be packed in a small carboard, then be taped on the drainer part. Or will be packed with the drainer separately.



Step 3

Pack into normal carton and seal with adhesive tape. DAYA also packs according to clients' requirements.



PALLET PACKAGE

Normal carton packing with plywood pallet (no fumigation required) and PP strap to fix the shower trays on the pallet, finally, using wrapping film outside to ensure the shower trays fixed well on the pallet.

SERIE F: 16-18pcs/pallet

SERIE I: 15pcs/pallet

SERIE M: 15-18pcs/pallet

SERIE K: 18pcs/pallet

SERIE L: 18pcs/pallet

SERIE G: 24pcs/pallet



FAQ

What is the origin of your products?

We have two factories in China. One in Shantou City, Guangdong Province, another one in Huaian City, Jiangsu Province. Both of our two factories produce shower trays and wash basins. You can make your choice.

Are you manufacturer or trade company?

We are the manufacturer specializes in manufacturing shower trays and wash basins for 24 years. Also we have large warehouse and quality control department.

What is your sample policy?

We can freely supply the sample if we have goods in stock, but the customers have to pay the freight charge.

Can I have our own OEM?

We have our professional technical team, we can design and produce products according to your ideas and requirements. We can build the molds and fixtures.

How about your delivery time?

Generally, it will take 30 days upon receipt of your payment. The specific delivery time depends on the item and the quantity of your order.

What is your payment term?

By 100% T/T, 30% in advance as deposit, and 70% should be paid against the copy of B/L.

What are your terms of price?

EXW or FOB.

Do you have a Minimum Order Quantity requirement?

Usually our MOQ requirement is a 20'GP container.

How do you ensure product quality?

You deserve the highest-quality product and packing services every single time. This is why our quality system extends throughout the whole production process until the final delivery. We have strict quality testing department and our own professional quality inspector to carefully follow up on all details.

What quality certificates can you provide?

We can provide CE certificate and ISO9001 for our shower trays.

Which countries are your products mainly sold to?

With unremitting efforts in the past 24 years, we have attracted customers from 26 countries. Such as Italy, France, UK, Austria, Netherlands and so on.

What happens if the product is damaged when I receive the goods?

If the damage is caused by our side before container loading, we will shoulder the responsibility and compensate for this product. If the damage is caused by transportation, and our term is usually FOB, you will need to claim this to your insurance company or shipping company.

How will you deal with the product break in your promised warranty?

Please send us photos of the broken product so we can know the problem and give you an appropriate solution, we can also prepare repair kit. If the problem cannot be solved after, we will compensate for this product.

Why should we choose your company over others?

After 24 years of development, DAYA is able to fulfill the professional capability of techniques research and production, and seek for greater perfection in every production step. Our professional technical team engages in designing and producing products to satisfy customer need and the market demand. "Quality First, Trustworthiness Cooperation, Mutual Benefit" is the general idea of DAYA, we hope to enter into business with you in the future.

Can you share your customers' names?

I am afraid we are not able to disclose their names because they require privacy. We owe a duty of care to our clients to prevent any risk of harm. If we can work together, we will also keep all of your information safe. Thanks for your understanding.

CUSTOM SERVICE



Product design and development company has a professional team, according to customer's idea, requirements, design to produce the every kind of products.



With its competitive advantage in manufacture and service, awards of contracts, and wins the trusts of clients at home and abroad, in order to reach and exceed customers' satisfaction.



Has the strict quality testing department, the safeguard customer's high grade request, and has own professional merchandiser to carefully following up on all details until the delivery.

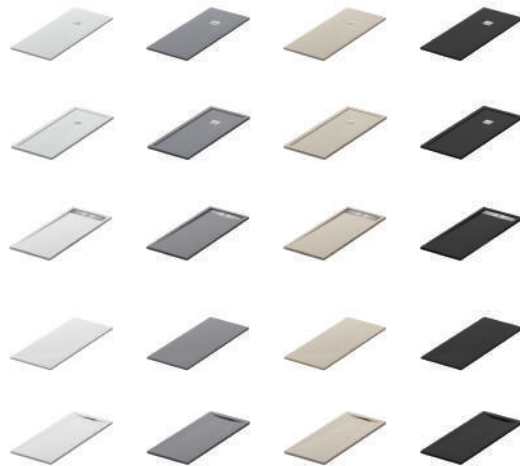

DAYA

THE MANUFACTURER OF
SHOWER TRAYS