

CATALOGUE OF SHOWER TRAY



2021



SGS



Specializing in manufacturing
shower tray and wash basin.

Spécialisé dans la fabrication de
receveurs de douche et de lavabos.

Specializzata nella produzione di
piatti doccia e lavabi.

Spezialisiert auf die Herstellung von
Duschwannen und Waschbecken.

EN . FR . IT . DE

1-6	About DAYA À propos de DAYA · A proposito di DAYA · Über DAYA
7-12	About shower tray À propos du Receveur de douche · A proposito di piatti doccia · Über Duschwanne
13-19	F series F Série · F Serie · F Serie
20-25	I series I Série · I Serie · I Serie
26-30	O series O Série · O Serie · O Serie
31-36	FQ series FQ Série · FQ Serie · FQ Serie
37-42	J series J Série · J Serie · J Serie
43-48	P series P Série · P Serie · P Serie
49-54	M series M Série · M Serie · M Serie
55-60	Q series Q Série · Q Serie · Q Serie
61-66	S series S Série · S Serie · S Serie
67-72	L series L Série · L Serie · L Serie
73-78	N series N Série · N Serie · N Serie
79-84	K series K Série · K Serie · K Serie
85-90	G series G Série · G Serie · G Serie
91-94	Drainer Bonde · Piletta · Ablauf
95-96	Installation of shower tray Installation du Receveur de douche · Installazione del piatti doccia · Installation der Duschwanne
97-98	Reparation of shower tray Réparation de Receveur de douche · Riparazione del piatti doccia · Reparatur der Duschwanne
99-100	Packaging of shower tray Emballage de · Confezionamento del · Verpackung der
101-104	Our branding service Notre service de marque · Il nostro servizio del marchio · Markenservice
105-108	Technical specifications Spécifications techniques · Technical specifications · Technische Spezifikation
109-112	FAQ Questions fréquentes · Domande frequenti · FAQ
113	Contact information Informations de contact · Informazioni di contatto · Kontakt

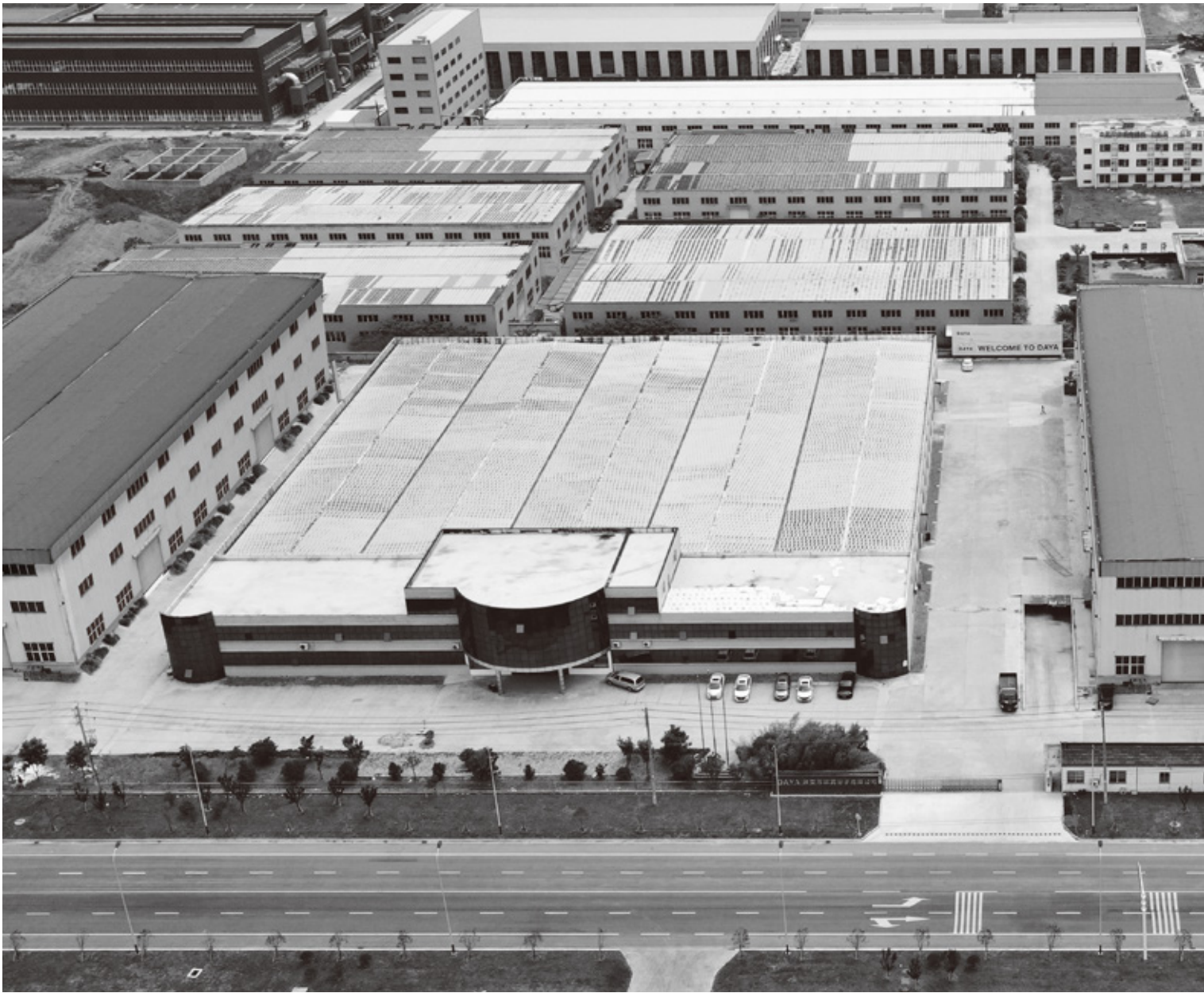

DAYA®

The Chinese manufacturer of shower tray.

DAYA SANI-WARE MFY. LTD, was established in Shantou (China) in 2000, and set up a plant in Huaian (China) in 2018. With unremitting efforts in the past 21 years, we have attracted customers from 26 countries, securing DAYA with a global reputation in the fields of sanitary, including shower enclosures, polymarble shower trays, resin wash basins.

Le fabricant chinois de receveur de douche.

DAYA SANI-WARE MFY. LTD, a été créée à Shantou (Chine) en 2000, et a établi une usine à Huaian (Chine) en 2018. Grâce à nos efforts incessants pendant les 21 dernières années, nous avons attiré des clients venant de 26 pays, établissant ainsi DAYA avec une réputation mondiale dans les domaines du sanitaire, y compris les parois de douche, les receveurs de douche en polymarbre, les lavabos en résine.



Il produttore cinese di piatto doccia.

DAYA SANI-WARE MFY. LTD, è stata fondata a Shantou (Cina) nel 2000 e la sua fabbrica è stata stabilita a Huaian (Cina) nel 2018. Grazie ai nostri impegni continui negli ultimi 21 anni, abbiamo attratto i clienti provenienti da 26 paesi, garantendo DAYA con una reputazione globale nei settori sanitari, tra cui box doccia, piatti doccia in polimarmo, lavabi in resina.

Der chinesische Hersteller von Duschwannen.

DAYA SANI-WARE MFY. LTD wurde im Jahr 2000 in Shantou (China) gegründet und errichtete ein Werk in Huai'an (China) im Jahr 2018. Durch unermüdliche Bemühungen in den letzten 21 Jahren hat DAYA Kontakte zu Kunden in 26 Ländern geknüpft. DAYA genießt weltweit einen guten Ruf im Bereich der Sanitäranlagen, inkl. Duschkabinen, Duschwannen aus Kunstmarmor, Waschbecken aus Harz.

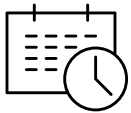

21 years

21 ans
21 anni
21 Jahre

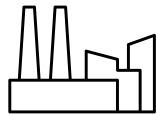

48,000m² factory area

48,000m² de fabrication
area di 48,000m²
48.000 m² Fabrikfläche

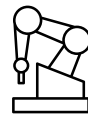

12,000 pcs/month

12,000 pièces/mois
12,000 pezzi/mese
12.000 Stück / Monat



48 countries

48 pays
48 paes
48 Länder

EN: Covering an area of 48,000 square meters with the latest technical equipment, based on the CE certification and the production capacity of 12,000 pieces per month, we can supply the prompt delivery to our customers from all the European market.

DAYA, a professional manufacturer which devotes to technology, innovation and high quality. We look forward to cooperating with you!

IT: Occupando un'area di 48.000 metri quadrati con le ultime attrezzature tecniche, in base al certificato CE e alla capacità di produzione di 12.000 pezzi al mese, forniamo una consegna pronta per i nostri clienti da tutti i mercati europei. DAYA, un produttore professionale che dedica a tecnologia, innovazione e alta qualità. Attendiamo con ansia di poter collaborare con voi!

FR: Avec une superficie de 48.000 mètres carrés et des équipements techniques de pointe, bénéficiant de la certification CE et d'une capacité de production de 12.000 pièces par mois, nous pouvons garantir une livraison efficace et rapide à nos clients sur tout le marché européen.

DAYA, un fabricant spécialisé qui est dévoué à la technologie, à l'innovation et à la haute qualité. Nous serons très heureux de coopérer avec vous!

DE: Auf einer Fläche von 48.000 Quadratmetern mit der neuesten technischen Ausstattung, mit der CE-Zertifizierung und einer Produktionskapazität von 12.000 Stück pro Monat, ist DAYA in der Lage, Kunden aus dem gesamten europäischen Markt zeitnah beliefern.

DAYA ist ein professioneller Hersteller, der sich der Technologie, Innovation und hohen Qualität verschrieben hat. Wir freuen uns auf die Zusammenarbeit mit Ihnen!



Office général et Fabrique A
 No.16-02-3 Ville industrielle de Jinyuan,
 Rue de Chaoshan, Ville de Shantou, Province de Guangdong, Chine

Fabrique B
 No.428 Avenue de Shenhua,
 Campagne de Jinhu, ville de Huaian, province de Jiangsu, Chine

Sede centrale & Fabbrica A
 Parco Industriale di Jinyuan No.16-02-3
 Via di Chaoshan, Città di Shantou, Provincia di Guangdong, Cina

Fabbrica B
 Corso di Shenhua No.428,
 Contea di Jinhu, Città di Huaian, Provincia di Jiangsu, Cina

Hauptsitz & Werk A
 Nr. 16-02-3 Industriestadt Jinyuan,
 Chaoshan Str., Stadt Shantou, Provinz Guangdong, China

Werk B
 Nr. 428 Shenhua Avenue,
 Gemeinde Jinhu, Stadt Huai'an, Provinz Jiangsu, China



MATERIAL COMPONENTS

COMPOSANTS MATÉRIELS · COMPONENTI DI MATERIALI · KOMPONENTEN DER MATERIALIEN

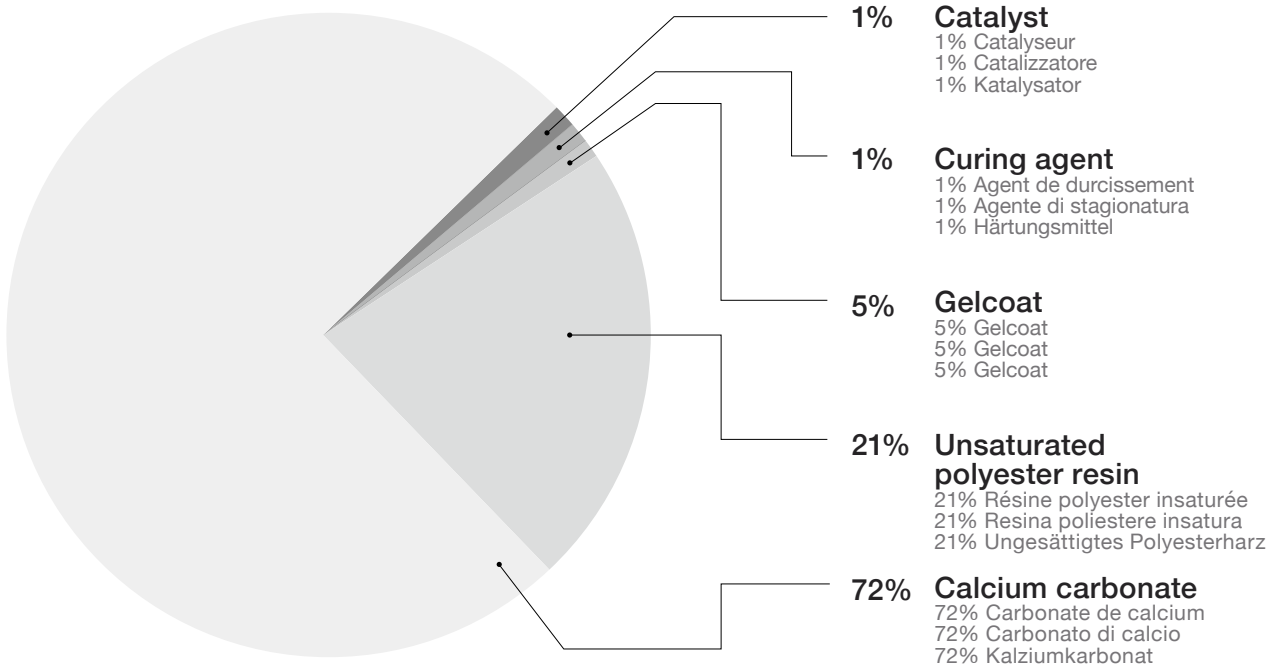

FEATURES OF PRODUCT

CARACTÉRISTIQUES GÉNÉRALES · CARATTERISTICHE PRINCIPALI · EIGENSCHAFTEN DES PRODUKTS



Anti-slip
Antidérapante
Antiscivolo
Rutschfeste



Mass coloration
Couleurs dans la masse
Massa coloratacoloration
In der Masse eingefärbt

- Slate stone and wooden texture.
- Extra-flat resin tray with mineral fillers.
- Lightened material (30% less weight).
- High-flow extra-flat drain valve included.
- Different grating finishes to choose from.
- Antibacterial and anti-slip Grade 3.



Ecological material
Matériau écologique
Materiale ecologico
Ökologisches Material



Antibacterial
Antibactérien
Antibatterico
Antibakteriell

- Texture ardoise, pierre et bois.
- Receveurs extra plats en résine avec charges minérales.
- Matériau allégé (30 % de poids en moins).
- Bonde d'écoulement extra plate à grand débit incluse.
- Diverses finitions de grille au choix.
- Antibactérienne et antidérapante classe 3.



Waterproof
Hydrofuge
Impermeabile
Wasserdicht



Easy to clean
Nettoyage facile
Pulizia facile
Leicht zu reinigen

- Pietra ardesia e struttura in legno.
- Piatto in resina ultra piano con cariche minerali.
- Materiale alleggerito (30% in meno di peso).
- Valvola di scarico extra piana ad alta portata inclusa.
- Diverse finiture della griglia tra cui scegliere.
- Grado 3 antibatterico e antiscivolo.



Cuttable
Découpe
Tagliabile
Schneidbar



Optional colours
Option couleurs
Colori Opzionali
Optionale Farben

- Schieferstein und Holzbeschaffenheit
- Extra-flache HarzDuschwanne mit mineralischen Füllstoffen.
- Leichteres Material (30% weniger Gewicht).
- Extra-flaches Ablauf mit hohem Durchfluss im Lieferumfang enthalten.
- Verschiedene Gitteroberflächen zur Auswahl.
- Antibakteriell und rutschfest Klasse 3.



Support repairs
Réparable
Support repairs
Unterstützung von Reparaturen



5 years guarantee
Garantie 5 ans
5 años de garantía
5 Jahre Garantie



Include drainers
Inclure bondes
Inclure piletta
Inkl. Abläufe



Include covers
Inclure grilles
Inclure griglia
Inkl. Gitter

PRODUCT ACCESSORIES

ACCESSOIRES DE PRODUIT · ACCESSORI DI PRODOTTO · PRODUKTZUBEHÖR

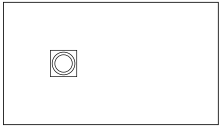

Shower Tray
 Receveur de douche
 Piatti doccia
 Duschanne

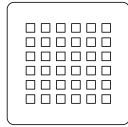

Cover
 Grille
 Griglia
 Gitter

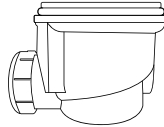

Drainer
 Bonde
 Piletta
 Ablauf



Installation Guide
 Installation Manuel
 Installazione Manuale
 Bedienungsanleitung

DAYA's shower tray includes:
 Main product - shower tray,
 Accessories - cover + drainer + instruction guide

Il piatto doccia di DAYA include:
 Il prodotto principale – piatto doccia,
 Accessori – griglia + piletta + istruzioni per l'uso

Le plateau de douche DAYA comprend :
 Produit principal - receveur de douche,
 Accessoires - grille + bonde + guide d'instructions

Die Duschanne von DAYA umfasst:
 Hauptprodukt - Duschanne,
 Zubehörteile – Gitter + Ablauf + Bedienungsanleitung

CERTIFICATE

CERTIFICAT · CERTIFICATO · ZERTIFIKAT

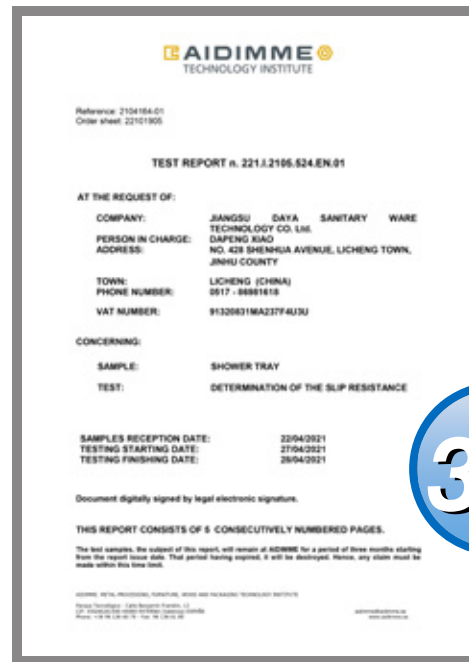

EN: All our products have CE certificate to guarantee the high quality and meet international standard. We produce all products in accordance with the international safety standard, including the raw material controlling and the production process.

FR: DAYA possède la certification CE, qui reconnaît les efforts de notre entreprise en matière de gestion de qualité, en implantant le respect des normes Européennes dans toutes les phases de la production: du design au service clients.

IT: Tutti i nostri prodotti hanno il certificato CE per garantire l'alta qualità e soddisfare lo standard internazionale.

DE: Alle unsere Produkte sind CE-zertifiziert, um eine hohe Qualität zu gewährleisten und internationalen Standards zu entsprechen. Wir stellen alle Produkte gemäß dem internationalen Sicherheitsstandard her, einschließlich Rohstoffkontrolle und Produktionsprozessen.

PROCESS OF PRODUCTION

PROCESSUS DE PRODUCTION · PRODUZIONE DI PROCESSO · PRODUKTIONSVERFAHREN

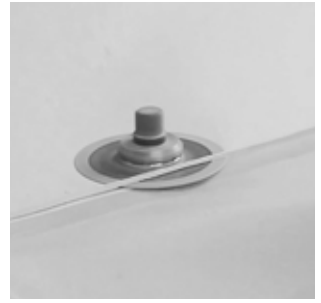

1



Mould
Moule
Stampo
Formen

Before production, we should check if the mould has any defect and then brush the grease on the back of the upper mould. (Function of grease: make it easier to clean the spilled injecting materials.)

Avant la production, il faut vérifier si le moule présente un quelconque défaut et ensuite brosser la graisse au dos du moule supérieur. (Fonction de la graisse : il faut faciliter le nettoyage des matériaux d'injection renversés).

Dobbiamo controllare se lo stampo ha qualche difetto e poi spazzolare il grasso sul retro dello stampo superiore prima della produzione. (Funzione del grasso: facilita la pulizia dei materiali di iniezione versati.)

Vor der Produktion sollten wir prüfen, ob die Form einen Defekt aufweist. Tragen Sie dann das Fett auf der Rückseite der oberen Form auf. (Funktion von Fett: Erleichterung der Reinigung der verschütteten injizierenden Materialien)

2

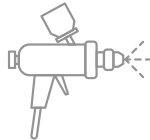

Spraying
Pulvérisation
Spruzzatura
Sprühen

Spray gel-coat on the mould. After spraying gel-coat, we should check whether the gel-coat was damaged or not and if thickness of gel-coat is qualified. Then put the tray into the industrial oven to dry the gel-coat.

Il faut vaporiser du gel-coat sur le moule. Après la pulvérisation du gel-coat, on vérifie si le gel-coat a été endommagé et si l'épaisseur du gel-coat est qualifiée. Puis mettre le plateau dans le four industriel pour sécher le gel-coat.

Spruzzare il gel coat sullo stampo. Dopo aver spruzzato il gel-coat, dobbiamo controllare se il gel-coat è stato danneggiato o no e se lo spessore del gel-coat è qualificato. Poi mettere il piatto nel forno industriale per asciugare il gel coat.

Sprühen Sie das Gelcoat auf die Form. Nach dem Sprühen von Gelcoat sollten wir prüfen, ob das Gelcoat beschädigt wurde oder nicht und ob die Dicke von Gelcoat qualifiziert ist. Dann wird die Wanne in einen Industrieofen gestellt, um das Gelcoat zu trocknen.

3



Injecting
Injection
Iniezione
Injizieren

After drying the gel-coat, combine the mould and inject resin material into the mould. Then wait for the material to be congealed.

Après le séchage du gel-coat, il faut combiner le moule et y injecter de la résine. Puis, attendez que la matière soit figée.

Dopo aver asciugato il gel-coat, combinare lo stampo e iniettare il materiale di resina nello stampo. Poi aspettare affinché il materiale sia congelato.

Nach dem Trocknen des Gelcoats kombinieren Sie die Form und spritzen Harzmaterial in die Form ein. Warten Sie dann, bis das Material erstarrt ist.

4

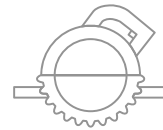

Trimming
Découpage
Taglio
Schneiden

When the shower tray has been shaped we can do the cutting. Place the tray horizontally and then cut the leftover material off by cutting machine.

Lorsque le receveur de douche a été façonné, on peut faire la découpe. Il faut placer le receveur à l'horizontale, puis couper les restes à l'aide d'une machine à découper.

Quando il piatto doccia è stato sagomato, possiamo iniziare a tagliare. Posizionare il piatto in modo orizzontale e poi tagliare il materiale rimasto con la macchina da taglio.

Wenn die Duschwanne geformt ist, können wir den Zuschnitt vornehmen. Stellen Sie die Wanne horizontal auf und schneiden Sie dann das Restmaterial mit einer Schneidemaschine ab.



5

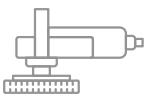

Polishing

Polissage
Lucidatura
Polieren

The shower tray will be sent to the area for polishing after cutting. Brush wax on the polishing machine and then polish the surface of the tray evenly.

Le receveur de douche sera envoyé dans la zone pour être poli après la coupe. Faire passer de la cire sur la machine à polir, puis polir la surface du plateau de manière uniforme.

Il piatto doccia sarà inviato nell'area di lucidatura in seguito al taglio. Spazzolare la cera sulla macchina di lucidatura e poi lucidare la superficie del piatto in modo uniforme.

Die Duschwanne wird nach dem Schneiden zum Polieren in den Bereich geschickt. Bürsten Sie das Wachs auf der Poliermaschine und polieren Sie dann die Oberfläche der Wanne gleichmäßig.



6

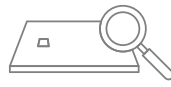

Inspection

Inspection
Ispezione
Inspektion

Our strict QC department checks the shower tray if deformed or not. If it's qualified, then clean the surface and the back side of the tray.

Notre département de contrôle de qualité rigoureux vérifie si le receveur de douche est déformé. S'il est qualifié, il nettoie alors la surface et l'arrière du receveur.

Il nostro reparto di controllo qualità rigoroso verifica il piatto doccia se è deformato o no. Se è qualificato, pulire la superficie e la parte posteriore del piatto.

Unsere Abteilung für strenge Qualitätskontrolle prüft Duschwannen auf Verformungen. Wenn es qualifiziert ist, wird die Oberfläche und die Rückseite der Wanne gereinigt.



7

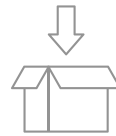

Packaging

Emballage
Imballaggio
Verpacken

The shower tray will be delivered to packaging department for packing after it is checked qualified completely.

Le receveur de douche sera remis au service d'emballage pour être empaqueté après avoir été entièrement contrôlé.

Il piatto doccia sarà consegnato al reparto di imballaggio per l'imballaggio se è considerato completamente qualificato.

Die Duschwanne wird zur Verpackung an die Verpackungsabteilung geliefert, nachdem sie vollständig qualifiziert geprüft wurde.

QUALITY

QUALITÉ · QUALITÀ · QUALITÄT



Anti-slip

Anti-dérapant · Antiscivolo · Rutschfest

Slate stone and wooden textures both achieve Class 3 anti-slip level according to Standard UNE 41901:2017.

La pierre d'ardoise et les textures en bois conforment au niveau antidérapant de classe 3 selon la norme UNE 41901:2017.

Sia la pietra ardesia sia le strutture di legno raggiungono il livello antiscivolo di Classe 3 secondo lo standard UNE 41901:2017.

Schiefersteine und Holztexturen erreichen beide die Rutschfestigkeit der Klasse 3 gemäß der Norm UNE 41901:2017.

Cuttable

Découpable · Tagliabile · Schneidbar

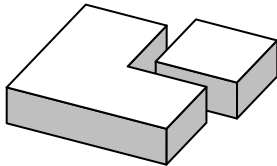

Shower trays are able to be cut into any shape and adapt to all kinds of bathroom space.

Les receveurs de douche ont la possibilité d'être découpés dans n'importe quelle forme et s'adaptent à tous les types d'espace de salle de bains.

I piatti doccia possono essere tagliati in qualsiasi forma e si adattano a tutti i tipi di spazio del bagno.

Duschwannen können in jede beliebige Form geschnitten werden und passen sich an alle Arten von Badezimmern an.

Pallet

Palette · Pallet · Palette

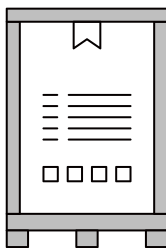

Shower trays are high-quality packed with pallet made by plywood, all pallets don't require fumigation.

Les receveurs de douche sont emballés de première qualité avec des palettes en contreplaqué, toutes les palettes n'ont pas besoin d'être fumigées.

I piatti doccia sono imballati di alta qualità con pallet realizzati in compensato, nessun pallet richiede la fumigazione.

Duschwannen sind hochwertig mit Paletten aus Sperrholz verpackt. Alle Paletten benötigen keine Begasung.

Product's quality certificate

Certificat de qualité du produit · Certificato della qualità di prodotto · Qualitätssertifikat des Produkts

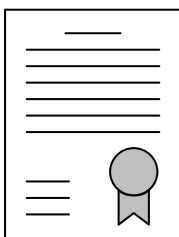

Our products achieved approval CE and SGS certificates and our factory passed through ISO9001.

Tous nos produits ont été approuvés par les certificats CE et SGS, notre usine est ainsi passée à la norme ISO9001.

I nostri prodotti hanno ottenuto i certificati CE e SGS e la nostra fabbrica è stata approvata con ISO9001.

Unsere Produkte wurden von CE und SGS zertifiziert. Unser Werk hat die ISO9001-Zertifizierung bestanden.

SERVICE, DESIGN

SERVICE, CONCEPTION · SERVICIO, DISEÑO · KUNDENDIENST, DESIGN

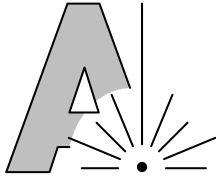

Laser Logo

Logo de laser · Laser di marchio · Laser-Logo

Lasering Logo by advanced laser machine to promote customers' brand popularity.

Le logo de laser est créé par une machine laser avancée pour promouvoir la popularité de la marque auprès des clients.

Incisione del marchio in laser con la macchina laser avanzata per promuovere la popolarità del marchio dei clienti.

Laser Logo durch fortschrittliche Lasermaschine zur Förderung der Markenbekanntheit der Kunden.

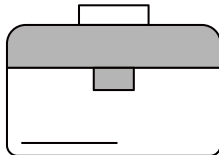

Repair kit. Supports repairs

Kit de · Kit di riparazione Supporto di manutenzione ·
Reparaturatz unterstützt Reparaturen

Our shower trays are repairable, we could provide repair kits for customers for repairing the goods by themselves.

Nos receveurs de douche sont réparables, nous pourrions fournir des kits de réparation aux clients pour qu'ils puissent réparer les produits par eux-mêmes.

I nostri piatti doccia sono riparabili, potremmo fornire i kit di riparazione ai clienti per riparare le merci da soli.

Unsere Duschwannen sind reparierbar. Wir könnten den Kunden Reparaturätze zur Verfügung stellen, damit sie die Waren selbst reparieren können.

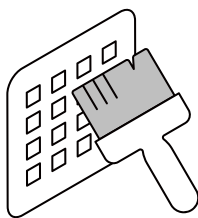

Accordant cover

Grille accordée · Griglia conforme · Entsprechende Abdeckung

The drainage cover with accordant color of the shower tray, making it perfectly structured and achieving an up-to-date minimalism bathroom.

La couverture de drainage avec la couleur harmonieuse du receveur de douche, fait parfaitement structuel en réalisant une salle de bain minimaliste et moderne.

Il griglia di scolo con il colore conforme al piatto doccia lo rende perfettamente strutturato e realizza un bagno moderno e minimalista.

Die Ablaufabdeckung mit der entsprechenden Farbe der Duschwanne macht sie perfekt strukturiert und sorgt für ein zeitgemäßes minimalistisches Badezimmer.

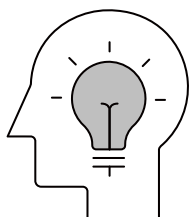

Custom-made

Personnalisé · Personalizzato · Kundenspezifisch

Professional R&D team devotes to designing products based on customers' requirements and users' feedback.

Une équipe professionnelle de R&D est consacrée à la conception de produits en fonction des demandes des clients et des commentaires des utilisateurs.

Il team di ricerca & sviluppo professionale si dedica alla progettazione di prodotti basata alle esigenze dei clienti e ai feedback degli utenti.

Ein professionelles F&E-Team widmet sich der Entwicklung von Produkten auf der Grundlage der Kundenanforderungen und des Feedbacks der Benutzer.

All Products

TOUS LES PRODUITS · TUTTI I PRODOTTI · ALLE PRODUKTE

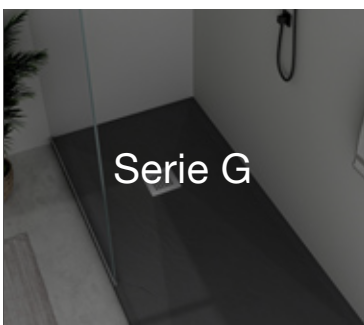
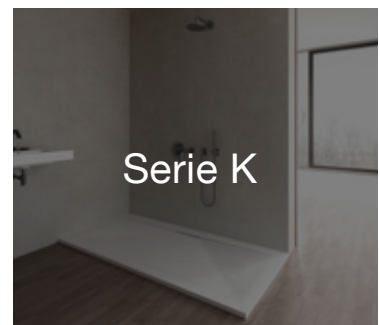
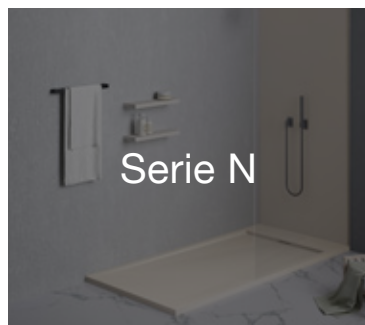
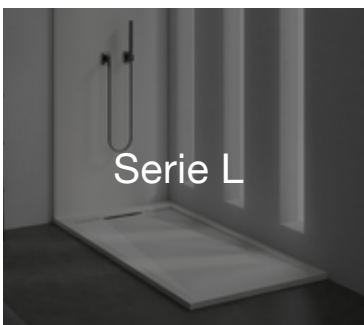
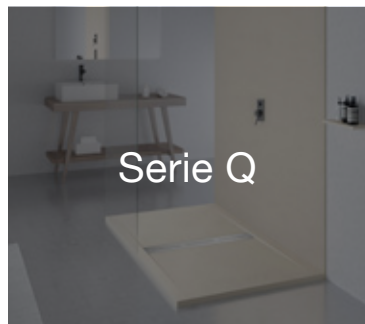
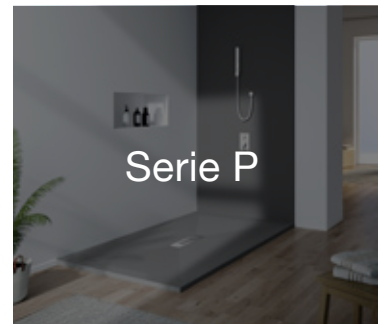

Serie F
Série F
Serie F
Serie F



Serie I
Série I
Serie I
Serie I



Serie O
Série O
Serie O
Serie O



Serie FQ
Série FQ
Serie FQ
Serie FQ



Serie J
Série J
Serie J
Serie J

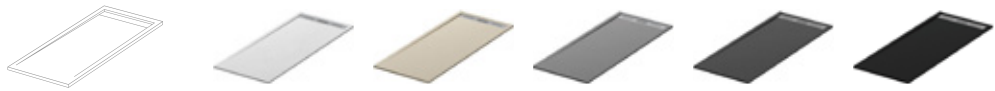

Serie P
Série P
Serie P
Serie P



Serie M
Série M
Serie M
Serie M

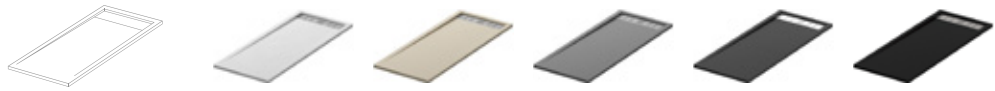

Serie Q
Série Q
Serie Q
Serie Q



Serie S
Série S
Serie S
Serie S



Serie L
Série L
Serie L
Serie L

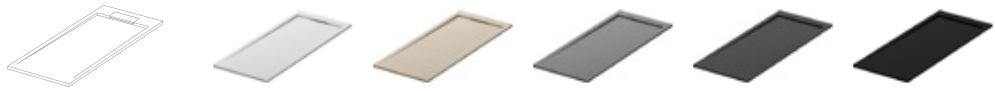

Serie N
Série N
Serie N
Serie N



Serie K
Série K
Serie K
Serie K



Serie G
Série G
Serie G
Serie G





SERIE F

EN: Serie F is a shower tray with simple design which provides the bathroom with a natural, comfortable and minimalist atmosphere. A shower tray with classical lines characterised by being extremely flat.

IT: Serie F è un piatto doccia con design semplice che offre al bagno un'atmosfera naturale, confortevole e minimalista. Un piatto doccia con linee classiche caratterizzato dall'essere estremamente piatto.

FR: Série F est un receveur de douche à la conception simple qui donne à la salle de bain une atmosphère naturelle, confortable et minimaliste. Un receveur de douche avec les lignes classiques, se caractérise par son excellente planéité.

DE: Die Serie F ist eine Duschwanne mit einfachem Design, die dem Badezimmer eine natürliche, komfortable und minimalistische Atmosphäre verleiht. Eine Duschwanne mit klassischer Linienführung, die sich durch ihre extreme Flachheit auszeichnet.



DAYA

Code: Serie F
Texture: Slate Stone Texture
Colours: White / Beige / Light Gray / Dark Gray / Black
Cover: Stainless steel grating as standard or optional painted grating

Article: Série F
Texture: Texture pierre ardoise
Couleurs: Blanc / Crème / Ciment / Anthracite / Noir
Grille: Grille en inox de série ou grille peinte en option

Articolo: Serie F
Texture: Pietra ardesia
Colori: Bianco / Crema / Cemento / Antracite / Nero
Coperchio: Griglia in acciaio inox standard o griglia verniciata opzionale

Code: Serie F
Oberflächen: Schieferstein-Textur
Farben: Weiß / Beige / Hellgrau / Dunkelgrau / Schwarz
Gitter: Standardmäßiger Edelstahlgitter oder optional lackiertes Gitter



Serie F

Shower Tray

Receveur de douche
Piatti doccia
Duschwannen

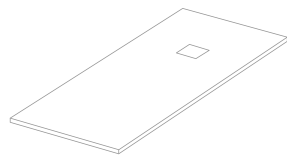

Length: 70-200 cm
Width: 70-100 cm
Height: 2.5/3 cm

Lunghezza: 80-200 cm
Larghezza: 70-100 cm
Altezza: 2.5/3 cm

Longueur: 80-200 cm
Largeur: 70-100 cm
Hauteur: 2.5/3 cm

Länge: 80-200 cm
Breite: 70-100 cm
Höhe: 2.5/3 cm

Texture

Texture
Finiture
Oberflächen

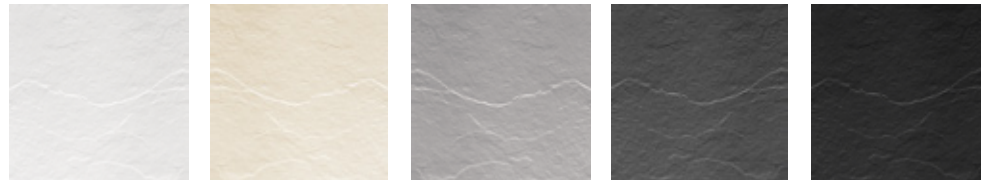

Available Colours

Couleurs disponibles
Colori disponibili
Verfügbare Farben

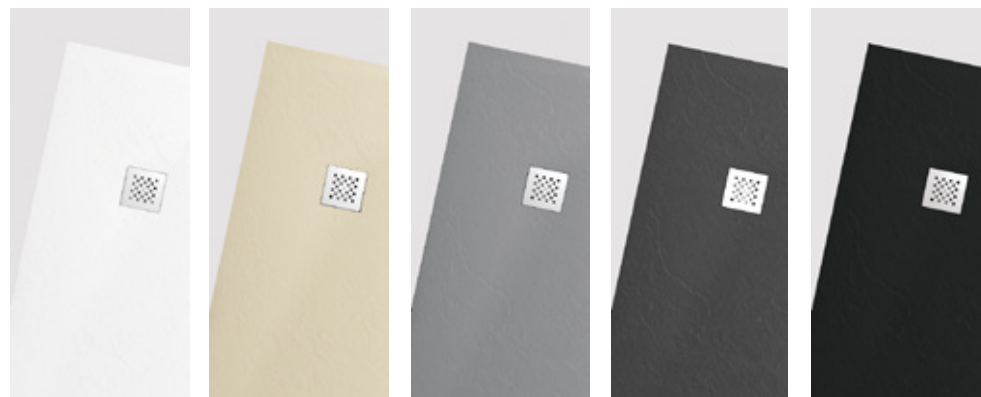

White
Blanc
Bianco
Weiß



Beige
Crème
Crema
Beige



Light Gray
Ciment
Cemento
Hellgrau



Dark Gray
Anthracite
Antracite
Dunkelgrau



Black
Noir
Nero
Schwarz

Cover

Grille
Griglia
Gitter



DY-1



DY-2



DY-2
white



DY-2
beige



DY-2
light gray

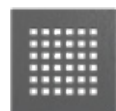

DY-2
dark gray



DY-2
black

★ Optional cover is supplied in the same colour as the shower tray.

La grille en option est livrée dans la même couleur que le receveur.

Il griglia opzionale è fornito nello stesso colore del piatto doccia.

Die optionale Gitter wird in der gleichen Farbe wie die Duschwanne geliefert.

Drainer

Bonde
Piletta
Ablauf



DY-11



DY-16



DY-132

The flow rate reaches 25.8 L/min.
Portata 25.8 litri al minuto.

Débit 25.8 litres par minute.
Die Durchflussrate erreicht 25.8 L / min.

DAYA

Code: Serie F
Texture: Slate Stone Texture
Colours: White / Beige / Light Gray / Dark Gray/ Black
Cover: Stainless steel grating as standard
or optional painted grating

Article: Série F
Texture: Texture pierre ardoise
Couleurs: Blanc / Crème / Ciment / Anthracite / Noir
Grille: Grille en inox de série ou grille
peinte en option

Articolo: Serie F
Texture: Pietra ardesia
Colori: Bianco / Crema / Cemento / Antracite / Nero
Coperchio: Griglia in acciaio inox standard
o griglia verniciata opzionale

Code: Serie F
Oberflächen: Schieferstein-Textur
Farben: Weiß / Beige / Hellgrau / Dunkelgrau / Schwarz
Gitter: Standardmäßiger Edelstahlgitter
oder optional lackiertes Gitter



Serie F

Dimensions

Dimensions
Dimensioni
Abmessungen

	70cm	80cm	90cm	100cm
70cm	DY-T077F			
80cm		DY-T088F		
90cm	DY-T097F		DY-T099F	
100cm	DY-T107F	DY-T108F	DY-T109F	DY-T1010F
110cm	DY-T117F	DY-T118F	DY-T119F	
120cm	DY-T127F	DY-T128F	DY-T129F	DY-T1210F
130cm	DY-T137F	DY-T138F	DY-T139F	
140cm	DY-T147F	DY-T148F	DY-T149F	DY-T1410F
150cm	DY-T157F	DY-T158F	DY-T159F	DY-T1510F
160cm	DY-T167F	DY-T168F	DY-T169F	DY-T1610F
170cm	DY-T177F	DY-T178F	DY-T179F	
180cm	DY-T187F	DY-T188F	DY-T189F	DY-T1810F
190cm	DY-T197F	DY-T198F	DY-T199F	
200cm		DY-T208F	DY-T209F	DY-T2010F



Thickness is 2.5cm for the width of 70cm and 80cm. Thickness is 2.5cm for the width of 90cm and 100cm, by the length under 120cm (includes 120cm). Thickness is 3.0cm for the width of 90cm and 100cm, by the length over 120cm.

Lo spessore è di 2.5cm per la larghezza di 70cm e 80cm. Lo spessore è di 2.5cm per la larghezza di 90cm e 100cm, per una lunghezza inferiore a 120cm (include 120cm). Lo spessore è di 3.0cm per la larghezza di 90cm e 100cm, dalla lunghezza oltre 120 cm.

Épaisseur de 2.5 cm pour la largeur de 70 cm et 80 cm. Épaisseur de 2.5 cm pour la largeur de 90 cm et 100 cm, avec une longueur inférieure à 120 cm (y compris 120 cm). Épaisseur de 3.0 cm pour la largeur de 90 cm et 100 cm, pour la longueur supérieure à 120 cm.

Die Dicke beträgt 2.5 cm bei einer Breite von 70 cm und 80 cm. Die Dicke beträgt 2.5 cm bei einer Breite von 90 cm und 100 cm, bei einer Länge unter 120 cm (einschließlich 120 cm). Die Dicke beträgt 3.0 cm bei einer Breite von 90 cm und 100 cm, bei einer Länge über 120 cm.

Drain Position

Position de la bonde
Posizione di scarico
Position des Ablauf

A	C
70cm	35cm
80cm	40cm
90cm	45cm

B	D
≥150cm	43cm
≤140cm	31cm

E	F
9cm	13.5cm

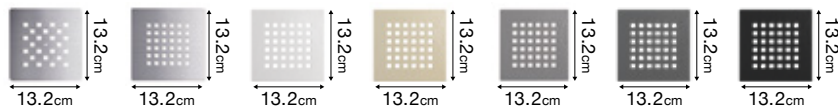
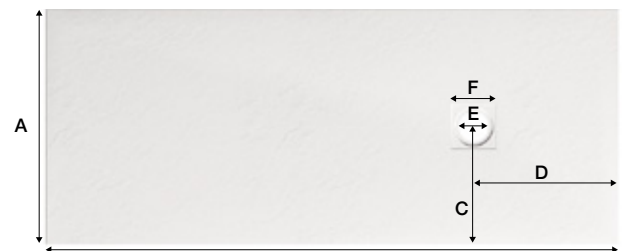

Thickness of cover : 1.2mm Épaisseur de la grille: 1.2mm Spessore del coperchio: 1.2mm Dicke der Gitter: 1.2mm

Features

Caractéristiques
Caratteristiche
Eigenschaften



Anti-slip
Antidérapante
Antiscivolo
Rutschfeste



Mass coloration
Couleurs dans la masse
Massa colorata
In der Masse eingefärbt



Ecological material
Matériau écologique
Materiale ecologico
Ökologisches Material



Antibacterial
Antibactérien
Antibatterico
Antibakteriell



Waterproof
Hydrofuge
Impermeabile
Wasserdicht



Easy to clean
Nettoyage facile
Pulizia facile
Leicht zu reinigen



Cuttable
Découpe
Tagliabile
Schneidbar



Optional colours
Option couleurs
Colori Opzionali
Optionale Farben



Support repairs
Réparable
Support repairs
Unterstützung von Reparaturen



5 years guarantee
Garantie 5 ans
Garanzia 5 anni
5 Jahre Garantie



Include drainers
Inclure bondes
Include piletta
Inkl. Abläufe



Include covers
Inclure grilles
Include griglia
Inkl. Gitter



SERIE

EN: Following the lines of the natural model, this series is suited to any situation as a result of its custom-made frame, which provides it with greater watertightness. Its adaptable sizes will blend into any environment.

FR: Conformément au modèle naturel, cette série s'adapte à toutes les situations grâce à son cadre spécialement conçu, qui lui confère une plus grande étanchéité. Ses dimensions adaptables conviennent à tous les environnements.

IT: Seguendo le linee del modello naturale, questa serie si adatta a qualsiasi situazione grazie al suo telaio fatto su misura, che offre una maggiore tenuta stagna. Le sue dimensioni appropriate si integrano in qualsiasi ambiente.

DE: In Anlehnung an natürliche Modelle eignet sich diese Serie aufgrund ihres maßgefertigten Rahmens für jede Situation, was zu einer größeren Wasserdichtigkeit führt. Seine anpassungsfähigen Größen passen sich jeder Umgebung an.



DAYA

Code: Serie I
Texture: Slate Stone Texture
Colours: White / Beige / Light Gray / Dark Gray / Black
Cover: Stainless steel grating as standard or optional painted grating

Article: Série I
Texture: Texture pierre ardoise
Couleurs: Blanc / Crème / Ciment / Anthracite / Noir
Grille: Grille en inox de série ou grille peinte en option

Articolo: Serie I
Finiture: Pietra ardesia texture
Colori: Bianco / Crema / Cemento / Antracite / Nero
Coperchio: Griglia in acciaio inox standard o griglia verniciata opzionale

Code: Serie I
Oberflächen: Schieferstein-Textur
Farben: Weiß / Beige / Hellgrau / Dunkelgrau / Schwarz
Gitter: Standardmäßiger Edstahlgitter oder optional lackiertes Gitter

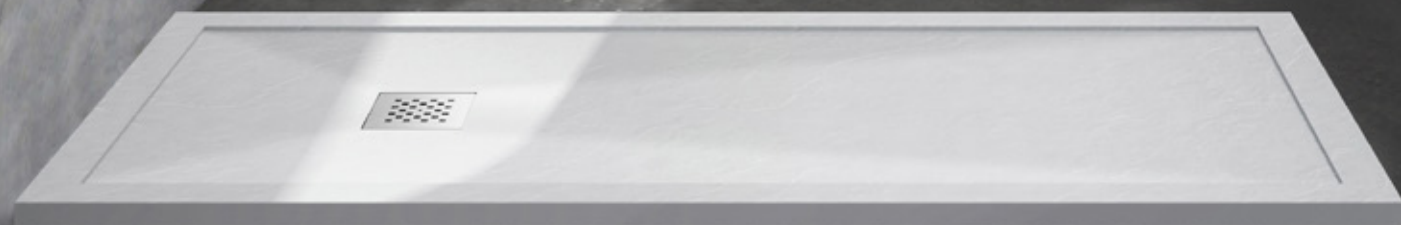

Serie I

Shower Tray

Receveur de douche
Piatti doccia
Duschwannen

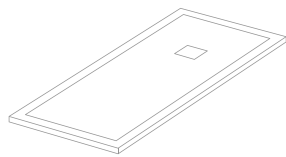

Length: 80-180 cm
Width: 70-90 cm
Height: 3.3 cm

Longueur: 80-180 cm
Largeur: 70-90 cm
Hauteur: 3.3 cm

Lunghezza: 80-180 cm
Larghezza: 70-90 cm
Altezza: 3.3 cm

Länge: 80-180 cm
Breite: 70-90 cm
Höhe: 3.3 cm

Texture

Texture
Finiture
Oberflächen

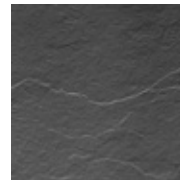
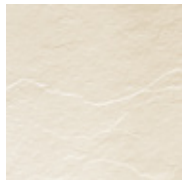
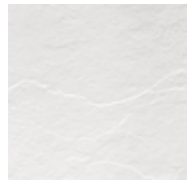

Available Colours

Couleurs disponibles
Colori disponibili
Verfügbare Farben



White
Blanc
Bianco
Weiß



Beige
Crème
Crema
Beige



Light Gray
Ciment
Cemento
Hellgrau



Dark Gray
Anthracite
Antracite
Dunkelgrau



Black
Noir
Nero
Schwarz

Cover

Grille
Griglia
Gitter



DY-1



DY-2



DY-2
white



DY-2
beige



DY-2
light gray



DY-2
dark gray



DY-2
black

* Optional cover is supplied in the same colour as the shower tray.

La grille en option est livrée dans la même couleur que le receveur.

Il griglia opzionale è fornito nello stesso colore del piatto doccia.

Die optionale Gitter wird in der gleichen Farbe wie die Duschwanne geliefert.

Drainer

Bonde
Piletta
Ablauf



DY-11



DY-16



DY-132

The flow rate reaches 25.8 L/min.
Portata 25.8 litri al minuto.

Débit 25.8 litres par minute.
Die Durchflussrate erreicht 25.8 L / min.

DAYA

Code: Serie I
Texture: Slate Stone Texture
Colours: White / Beige / Light Gray / Dark Gray / Black
Cover: Stainless steel grating as standard or optional painted grating

Article: Série I
Texture: Texture pierre ardoise
Couleurs: Blanc / Crème / Ciment / Anthracite / Noir
Grille: Grille en inox de série ou grille peinte en option

Articolo: Serie I
Finiture: Pietra ardesia texture
Colori: Bianco / Crema / Cemento / Antracite / Nero
Coperchio: Griglia in acciaio inox standard o griglia verniciata opzionale

Code: Serie I
Oberflächen: Schieferstein-Textur
Farben: Weiß / Beige / Hellgrau / Dunkelgrau / Schwarz
Gitter: Standardmäßiger Edstahlgitter oder optional lackiertes Gitter



Serie I

Dimensions

Dimensions
Dimensioni
Abmessungen

	70cm	80cm	90cm
80cm		DY-T088I	
90cm	DY-T097I		DY-T099I
100cm	DY-T107I	DY-T108I	
110cm	DY-T117I	DY-T118I	
120cm	DY-T127I	DY-T128I	
130cm	DY-T137I	DY-T138I	
140cm	DY-T147I	DY-T148I	
150cm	DY-T157I	DY-T158I	
160cm	DY-T167I	DY-T168I	
170cm	DY-T177I	DY-T178I	
180cm	DY-T187I	DY-T188I	

Thickness: 3.3cm
Épaisseur: 3.3 cm
Spessore: 3.3cm
Dicke: 3.3cm



For other sizes,
please contact with the
sales department

En ce qui concerne les
autres tailles, il faut contacter
le service des ventes

Per altre dimensioni, si
prega di contattare il
reparto di vendita.

Für andere Größen
wenden Sie sich bitte an
die Verkaufsabteilung.

Drain Position

Position de la bonde
Posizione di scarico
Position des Ablauf

A	C
70cm	35cm
80cm	40cm
90cm	45cm

B	D
≥150cm	43cm
≤140cm	31cm

E	F
9cm	13.5cm

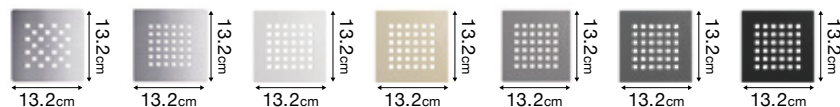

Thickness of cover : 1.2mm Épaisseur de la grille: 1.2mm Spessore del coperchio: 1.2mm Dicke der Gitter: 1.2mm

Features

Caractéristiques
Caratteristiche
Eigenschaften

 **Anti-slip**
Antidérapante
Antiscivolo
Rutschfeste

 **Mass coloration**
Couleurs dans la masse
Massa colorata
In der Masse eingefärbt

 **Ecological material**
Matériau écologique
Materiale ecologico
Ökologisches Material

 **Antibacterial**
Antibactérien
Antibatterico
Antibakteriell

 **Waterproof**
Hydrofuge
Impermeabile
Wasserdicht

 **Easy to clean**
Nettoyage facile
Pulizia facile
Leicht zu reinigen

 **Cutttable**
Découpe
Tagliabile
Schneidbar

 **Optional colours**
Option couleurs
Colori Opzionali
Optionale Farben

 **Support repairs**
Réparable
Support repairs
Unterstützung von Reparaturen

 **5 years guarantee**
Garantie 5 ans
Garanzia 5 anni
5 Jahre Garantie

 **Include drainers**
Inclure bondes
Include piletta
Inkl. Abläufe

 **Include covers**
Inclure grilles
Include griglia
Inkl. Gitter

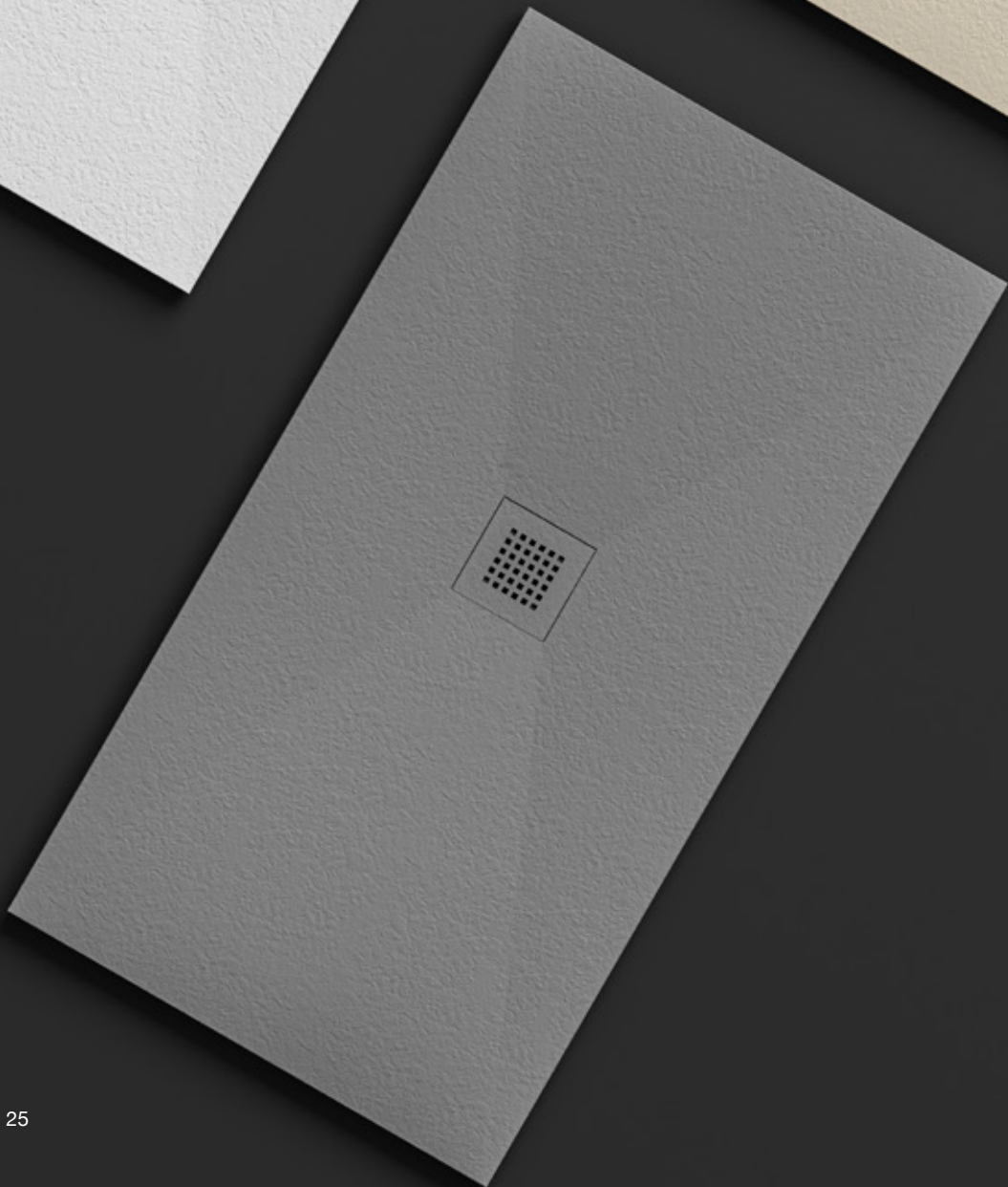

SERIE

O

EN: Serie O is characterised by its drain in the middle, making it perfectly structured. Created with polyester resin, especially adapted to humid areas. Available in a variety of sizes to suit every space.

IT: La serie O è caratterizzata dallo scarico in centro, che la rende perfettamente strutturata. Creato con resina poliestere, in particolare adatto per aree umide. Disponibile in una varietà di dimensioni per adattarsi a ogni spazio.

FR: La Série O est caractérisée par son drain au milieu, faisant parfaitement structuel. Elle est créée avec la résine polyester, adapte particulièrement aux zones humides. Plusieurs tailles sont disponibles pour mieux s'adapter à chaque espace.

DE: Die Serie O zeichnet sich durch ihren Ablauf in der Mitte aus, wodurch sie perfekt strukturiert ist. Hergestellt aus Polyesterharz, besonders geeignet für feuchte Bereiche. Eine Vielzahl von Größen für jeden Raum ist verfügbar.



DAYA

Code: Serie O
Texture: Stone Texture
Colours: White / Beige / Light Gray / Dark Gray / Black
Cover: Stainless steel grating as standard or optional painted grating

Articolo: Serie O
Finiture: Trama di pietra
Colori: Bianco / Crema / Cemento / Antracite / Nero
Coperchio: Griglia in acciaio inox standard o griglia verniciata opzionale

Article: Série O
Texture: Texture de pierre
Couleurs: Blanc / Crème / Ciment / Anthracite / Noir
Grille: Grille en inox de série ou grille peinte en option

Code: Serie O
Oberflächen: Stein Textur
Farben: Weiß / Beige / Hellgrau / Dunkelgrau / Schwarz
Gitter: Standardmäßiger Edelstahlgitter oder optional lackiertes Gitter

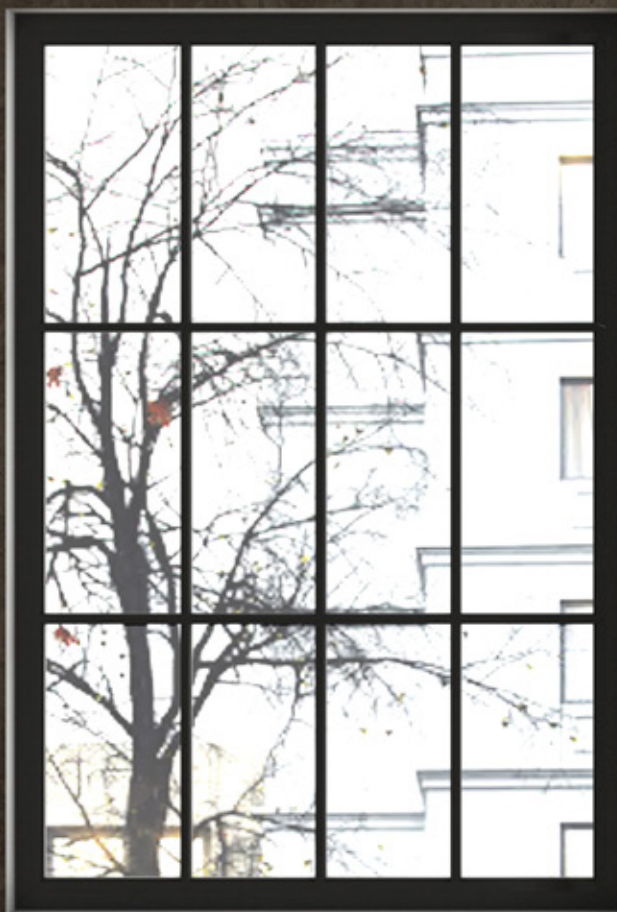

Serie O

Shower Tray

Receveur de douche
Piatti doccia
Duschwannen

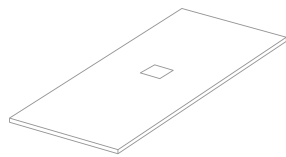

Length: 100-180 cm
Width: 70-80 cm
Height: 2.5 cm

Longueur: 100-180 cm
Largeur: 70-80 cm
Hauteur: 2.5 cm

Lunghezza: 100-180 cm
Larghezza: 70-80 cm
Altezza: 2.5 cm

Länge: 100-180 cm
Breite: 70-80 cm
Höhe: 2.5 cm

Texture

Texture
Finiture
Oberflächen

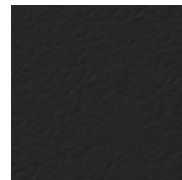
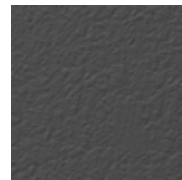
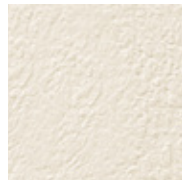
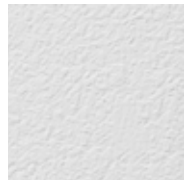

Available Colours

Couleurs disponibles
Colori disponibili
Verfügbare Farben

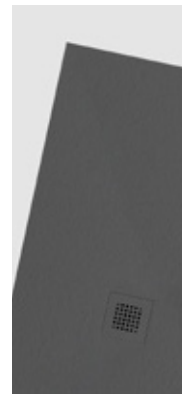

White
Blanc
Bianco
Weiß

Beige
Crème
Crema
Beige

Light Gray
Ciment
Cemento
Hellgrau

Dark Gray
Anthracite
Antracite
Dunkelgrau

Black
Noir
Nero
Schwarz

Cover

Grille
Griglia
Gitter



DY-1

DY-2

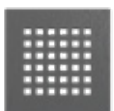

DY-2
white

DY-2
beige

DY-2
light gray

DY-2
dark gray

DY-2
black

* Optional cover is supplied in the same colour as the shower tray.

La grille en option est livrée dans la même couleur que le receveur.

Il griglia opzionale è fornito nello stesso colore del piatto doccia.

Die optionale Gitter wird in der gleichen Farbe wie die Duschwanne geliefert.

Drainer

Bonde
Piletta
Ablauf



DY-11

DY-16

DY-132

The flow rate reaches 25.8 L/min.
Portata 25.8 litri al minuto.

Débit 25.8 litres par minute.
Die Durchflussrate erreicht 25.8 L / min.

DAYA

Code: Serie O
Texture: Stone Texture
Colours: White / Beige / Light Gray / Dark Gray / Black
Cover: Stainless steel grating as standard or optional painted grating

Article: Série O
Texture: Texture de pierre
Couleurs: Blanc / Crème / Ciment / Anthracite / Noir
Grille: Grille en inox de série ou grille peinte en option

Articolo: Serie O
Finiture: Trama di pietra
Colori: Bianco / Crema / Cemento / Antracite / Nero
Coperchio: Griglia in acciaio inox standard o griglia verniciata opzionale

Code: Serie O
Oberflächen: Stein Textur
Farben: Weiß / Beige / Hellgrau / Dunkelgrau / Schwarz
Gitter: Standardmäßiger Edstahlgitter oder optional lackiertes Gitter



Serie O

Dimensions

Dimensions
Dimensioni
Abmessungen

	70cm	80cm
100cm	DY-T107O	DY-T108O
120cm	DY-T127O	DY-T128O
140cm	DY-T147O	DY-T148O
160cm	DY-T167O	DY-T168O
180cm	DY-T187O	DY-T188O

Thickness: 2.5cm
Épaisseur: 2.5cm
Grosor: 2.5cm
Thickness: 2.5cm

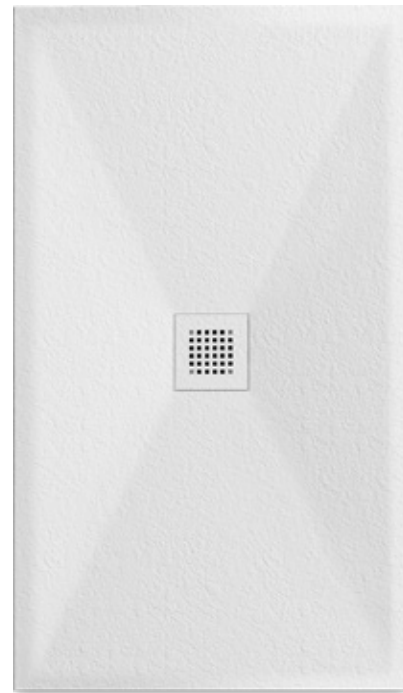

For other sizes,
please contact with the
sales department

En ce qui concerne les
autres tailles, il faut contacter
le service des ventes

Per altre dimensioni, si
prega di contattare il
reparto di vendita.

Für andere Größen
wenden Sie sich bitte an
die Verkaufsabteilung.

Drain Position

Position de la bonde
Posizione di scarico
Position des Ablauf

A	C
70cm	28.25cm
80cm	33.25cm

E	F
9cm	13.5cm

B	D
100cm	43.25cm
120cm	53.25cm
140cm	63.25cm
160cm	73.25cm
180cm	83.25cm

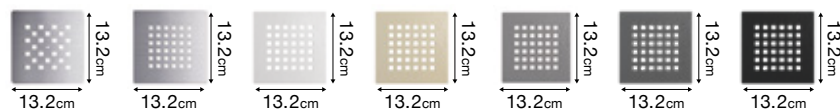
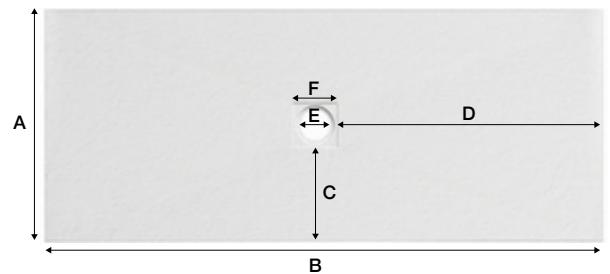

Thickness of cover : 1.2mm Épaisseur de la grille: 1.2mm Spessore del coperchio: 1.2mm Dicke der Gitter: 1.2mm

Features

Caractéristiques
Caratteristiche
Eigenschaften



Anti-slip
Antidérapante
Antiscivolo
Rutschfeste



Mass coloration
Couleurs dans la masse
Massa colorata
In der Masse eingefärbt



Ecological material
Matériau écologique
Materiale ecologico
Ökologisches Material



Antibacterial
Antibactérien
Antibatterico
Antibakteriell



Waterproof
Hydrofuge
Impermeabile
Wasserdicht



Easy to clean
Nettoyage facile
Pulizia facile
Leicht zu reinigen



Cuttable
Découpe
Tagliabile
Schneidbar



Optional colours
Option couleurs
Colori Opzionali
Optionale Farben



Support repairs
Réparable
Support repairs
Unterstützung von Reparaturen



5 years guarantee
Garantie 5 ans
Garanzia 5 anni
5 Jahre Garantie



Include drainers
Inclure bondes
Include piletta
Inkl. Abläufe



Include covers
Inclure grilles
Include griglia
Inkl. Gitter



SERIE

FQ

EN: A timeless classic thanks to the simplicity of its lines. It's the shower tray that adapts to all spaces thanks to the format customization options. Its special shape achieves a unique look for your bathroom.

IT: Un classico eterno grazie alla semplicità delle sue linee. È il piatto doccia che si adatta a tutti gli spazi grazie alle opzioni del formato personalizzato. La sua forma speciale porta un aspetto unico al tuo bagno.

FR: Un classique intemporel grâce à la simplicité de ses lignes. C'est le receveur de douche qui est adapté à tous les espaces grâce aux options de personnalisation du format. De plus, sa forme spéciale lui confère un esthétisme unique pour votre salle de bains.

DE: Ein zeitloser Klassiker dank der Schlichtheit seiner Linienführung. Mithilfe der Anpassungsoptionen der Format kann die Duschwanne an alle Räume angepasst werden. Seine besondere Form verleiht Ihrem Badezimmer eine einzigartige Optik.

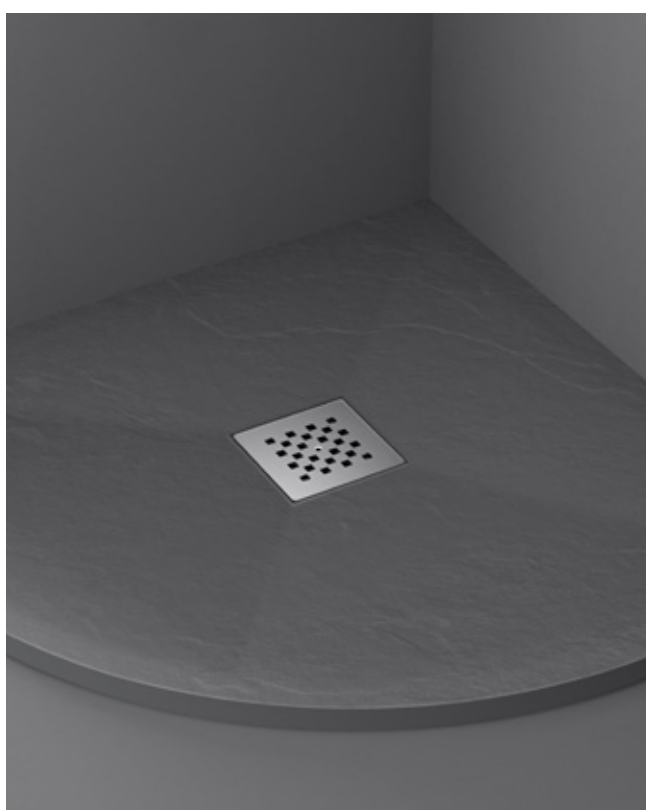

DAYA

Code: Serie FQ
Texture: Slate Stone Texture
Colours: White / Beige / Light Gray / Dark Gray / Black
Cover: Stainless steel grating as standard or optional painted grating

Article: Série FQ
Texture: Texture pierre ardoise
Couleurs: Blanc / Crème / Ciment / Anthracite / Noir
Grille: Grille en inox de série ou grille peinte en option

Articolo: Serie FQ
Finiture: Pietra ardesia texture
Colori: Bianco / Crema / Cemento / Antracite / Nero
Coperchio: Griglia in acciaio inox standard o griglia verniciata opzionale

Code: Serie FQ
Oberflächen: Schieferstein-Textur
Farben: Weiß / Beige / Hellgrau / Dunkelgrau / Schwarz
Gitter: Standardmäßiger Edelstahlgitter oder optional lackiertes Gitter



Serie FQ

Shower Tray

Receveur de douche
Piatti doccia
Duschwannen

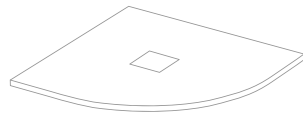

Length: 80-100 cm
Width: 80-100 cm
Height: 2.5cm

Longueur: 80-100 cm
Largeur: 80-100 cm
Hauteur: 2.5 cm

Lunghezza: 80-100 cm
Larghezza: 80-100 cm
Altezza: 2.5 cm

Länge: 80-100 cm
Breite: 80-100 cm
Höhe: 2.5 cm

Texture

Texture
Finiture
Oberflächen

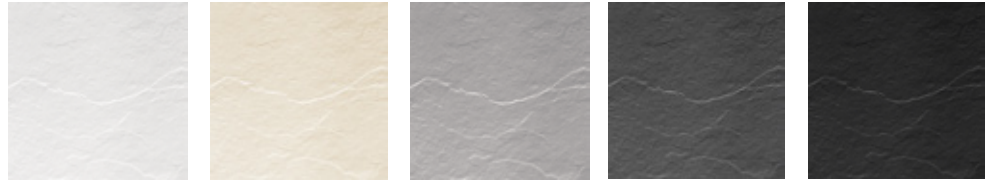

Available Colours

Couleurs disponibles
Colori disponibili
Verfügbare Farben



White
Blanc
Bianco
Weiß



Beige
Crème
Crema
Beige



Light Gray
Ciment
Cemento
Hellgrau



Dark Gray
Anthracite
Antracite
Dunkelgrau



Black
Noir
Nero
Schwarz

Cover

Grille
Griglia
Gitter



DY-1



DY-2



DY-2
white



DY-2
beige



DY-2
light gray

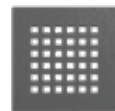

DY-2
dark gray



DY-2
black

* Optional cover is supplied in the same colour as the shower tray.

La grille en option est livrée dans la même couleur que le receveur.

Il griglia opzionale è fornito nello stesso colore del piatto doccia.

Die optionale Gitter wird in der gleichen Farbe wie die Duschwanne geliefert.

Drainer

Bonde
Piletta
Ablauf



DY-11



DY-16



DY-132

The flow rate reaches 25.8 L/min.
Portata 25.8 litri al minuto.

Débit 25.8 litres par minute.

Die Durchflussrate erreicht 25.8 L / min.

DAYA

Code: Serie FQ
Texture: Slate Stone Texture
Colours: White / Beige / Light Gray / Dark Gray / Black
Cover: Stainless steel grating as standard or optional painted grating

Article: Série FQ
Texture: Texture pierre ardoise
Couleurs: Blanc / Crème / Ciment / Anthracite / Noir
Grille: Grille en inox de série ou grille peinte en option

Articolo: Serie FQ
Finiture: Pietra ardesia texture
Colori: Bianco / Crema / Cemento / Antracite / Nero
Coperchio: Griglia in acciaio inox standard o griglia verniciata opzionale

Code: Serie FQ
Oberflächen: Schieferstein-Textur
Farben: Weiß / Beige / Hellgrau / Dunkelgrau / Schwarz
Gitter: Standardmäßiger Edelstahlgitter oder optional lackiertes Gitter



Serie FQ

Dimensions

Dimensions
Dimensioni
Abmessungen

	80cm	90cm	100cm
80cm	DY-T088FQ		
90cm	DY-T099FQ		
100cm	DY-T1010FQ		

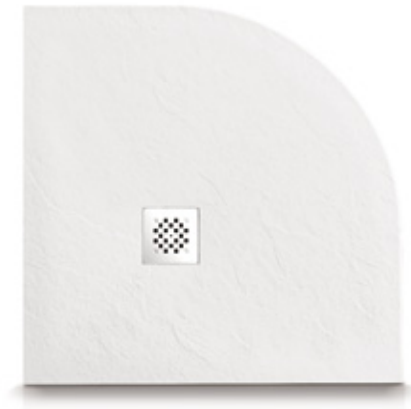

Thickness: 2.5cm
Épaisseur: 2.5cm
Grosor: 2.5cm
Thickness: 2.5cm

For other sizes,
please contact with the
sales department

En ce qui concerne les
autres tailles, il faut contacter
le service des ventes

Per altre dimensioni, si
prega di contattare il
reparto di vendita.

Für andere Größen
wenden Sie sich bitte an
die Verkaufsabteilung.

Drain Position

Position de la bonde
Posizione di scarico
Position des Ablauf

A	C
80cm	35cm
90cm	35cm
100cm	35cm

B	D
80cm	35cm
90cm	35cm
100cm	35cm

G	H
25cm	25cm
35cm	35cm
45cm	45cm

E	F
9cm	13.5cm

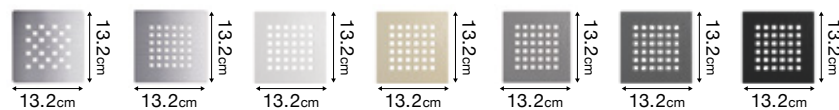
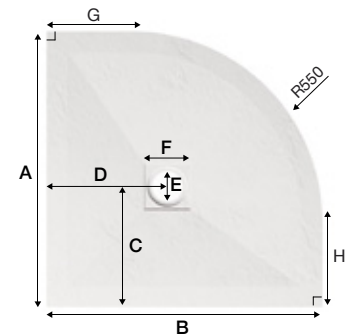

Thickness of cover : 1.2mm Épaisseur de la grille: 1.2mm Spessore del coperchio: 1.2mm Dicke der Gitter: 1.2mm

Features

Caractéristiques
Caratteristiche
Eigenschaften

 **Anti-slip**
Antidérapante
Antiscivolo
Rutschfeste

 **Mass coloration**
Couleurs dans la masse
Massa colorata
In der Masse eingefärbt

 **Ecological material**
Matériau écologique
Materiale ecologico
Ökologisches Material

 **Antibacterial**
Antibactérien
Antibatterico
Antibakteriell

 **Waterproof**
Hydrofuge
Impermeabile
Wasserdicht

 **Easy to clean**
Nettoyage facile
Pulizia facile
Leicht zu reinigen

 **Cutttable**
Découpe
Tagliabile
Schneidbar

 **Optional colours**
Option couleurs
Colori Opzionali
Optionale Farben

 **Support repairs**
Réparable
Support repairs
Unterstützung von Reparaturen

 **5 years guarantee**
Garantie 5 ans
Garanzia 5 anni
5 Jahre Garantie

 **Include drainers**
Inclure bondes
Include piletta
Inkl. Abläufe

 **Include covers**
Inclure grilles
Include griglia
Inkl. Gitter



SERIE J

EN: Serie J creates a slate stone texture that is an aesthetic and conceptual element of the bathroom that also works to arouse sensitivity to the need to respect water as an essential resource for humanity.

IT: La serie J crea una struttura di pietra ardesia che è un elemento estetico e concettuale del bagno che funziona anche per risvegliare la sensibilità alla necessità di rispettare l'acqua come una risorsa essenziale per umani.

FR: La série J crée une texture de pierre d'ardoise qui constitue un élément conceptuel et esthétique de la salle de bain . Elle contribue également à éveiller la sensibilité à la nécessité de respecter l'eau en tant que la ressource indispensable à l'humanité.

DE: Die Serie J schafft eine Schiefersteintextur, die ein ästhetisches und konzeptionelles Element des Badezimmers darstellt. Gleichzeitig weckt die Sensibilität der Menschen für die Notwendigkeit, Wasser als eine wesentliche Ressource für die Menschheit zu respektieren.



DAYA

Code: Serie J
Texture: Slate Stone Texture
Colours: White / Beige / Light Gray / Dark Gray / Black
Cover: Stainless steel grating as standard or optional painted grating

Articolo: Serie J
Finiture: Pietra ardesia texture
Colori: Bianco / Crema / Cemento / Antracite / Noir
Coperchio: Griglia in acciaio inox standard o griglia verniciata opzionale

Artículo: Serie J
Textura: Piedra de pizarra
Colores: Blanco / Crema / Cemento / Antracita / Nero
Rejilla: Rejilla inox de serie

Code: Serie J
Oberflächen: Schieferstein-Textur
Farben: Weiß / Beige / Hellgrau / Dunkelgrau / Schwarz
Gitter: Standardmäßiger Edelstahlgitter oder optional lackiertes Gitter

Serie J

Shower Tray

Receveur de douche
Piatti doccia
Duschwannen

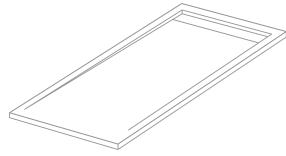

Length: 80-200 cm
Width: 70-100 cm
Height: 2.5/2.8/3.0/3.3 cm

Longueur: 80-200 cm
Largeur: 70-100 cm
Hauteur: 2.5/2.8/3.0/3.3 cm

Lunghezza: 80-200 cm
Larghezza: 70-100 cm
Altezza: 2.5/2.8/3.0/3.3 cm

Länge: 80-200 cm
Breite: 70-100 cm
Höhe: 2.5/2.8/3.0/3.3 cm

Texture

Texture
Finiture
Oberflächen



Available Colours

Couleurs disponibles
Colori disponibili
Verfügbare Farben

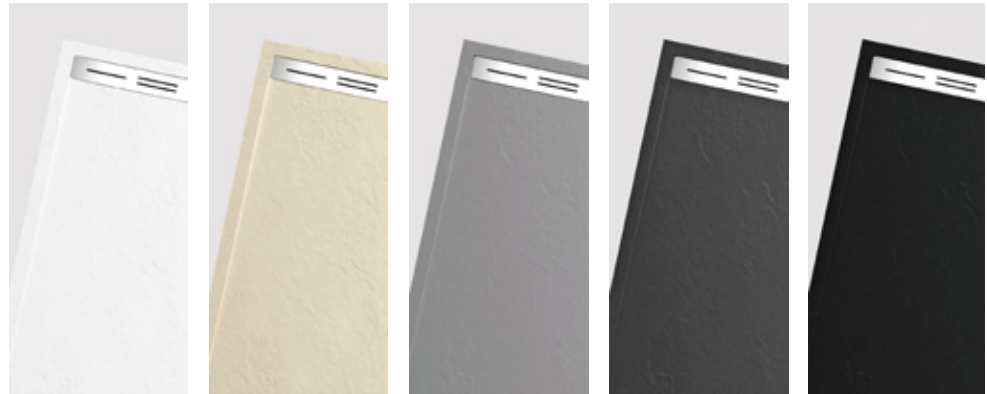

White
Blanc
Bianco
Weiß



Beige
Crème
Crema
Beige



Light Gray
Ciment
Cemento
Hellgrau



Dark Gray
Anthracite
Antracite
Dunkelgrau



Black
Noir
Nero
Schwarz

Cover

Grille
Griglia
Gitter



cover 9

Drainer

Bonde
Piletta
Ablauf



DY-611

The flow rate reaches 24 L/min.
Portata 24 litri al minuto.

Débit 24 litres par minute.
Die Durchflussrate erreicht 24 L / min.

DAYA

Code: Serie J
Texture: Slate Stone Texture
Colours: White / Beige / Light Gray / Dark Gray / Black
Cover: Stainless steel grating as standard or optional painted grating

Articolo: Serie J
Finiture: Pietra ardesia texture
Colori: Bianco / Crema / Cemento / Antracite / Noir
Coperchio: Griglia in acciaio inox standard o griglia verniciata opzionale

Artículo: Serie J
Textura: Piedra de pizarra
Colores: Blanco / Crema / Cemento / Antracita / Nero
Rejilla: Rejilla inox de serie

Code: Serie J
Oberflächen: Schieferstein-Textur
Farben: Weiß / Beige / Hellgrau / Dunkelgrau / Schwarz
Gitter: Standardmäßiger Edelstahlgitter oder optional lackiertes Gitter



Serie J

Dimensions

Dimensions
Dimensioni
Abmessungen

	70cm	80cm	90cm	100cm
80cm		DY-T088J		
90cm			DY-T099J	
100cm	DY-T107J	DY-T108J	DY-T109J	
110cm	DY-T117J	DY-T118J		
120cm	DY-T127J	DY-T128J	DY-T129J	DY-T1210J
130cm	DY-T137J	DY-T138J		
140cm	DY-T147J	DY-T148J	DY-T149J	DY-T1410J
150cm	DY-T157J	DY-T158J		
160cm	DY-T167J	DY-T168J	DY-T169J	DY-T1610J
170cm	DY-T177J	DY-T178J		
180cm	DY-T187J	DY-T188J		
200cm		DY-T208J	DY-T209J	DY-T2010J



For the width of 70cm and 80cm, thickness is 2.5cm by the length under 120cm (includes 120cm); thickness is 3.0cm by the length over 120cm and under 160cm (includes 160cm); thickness is 3.3cm by the length over 170cm (includes 170cm).
For the width of 90cm and 100cm, thickness is 2.8cm by the length under 120cm (includes 120cm); thickness is 3.3cm by the length over 140cm (includes 140cm).

Pour la largeur de 70cm, 80 cm, une épaisseur est à 2.5 cm par la longueur inférieure à 120 cm (y compris 120 cm); une épaisseur est à 3.0 cm par la longueur de plus de 120 cm et en dessous de 160 cm (y compris 160 cm); une épaisseur est de à 3.3 cm par la longueur de plus de 170 cm (y compris 170 cm).
Pour la largeur de 90 cm, une épaisseur est à 2.8 cm par la longueur inférieure à 120 cm (y compris 120 cm); une épaisseur est à 3.3 cm par la longueur de plus de 140 cm (y compris 140 cm).

Per la larghezza di 70cm, 80 cm, lo spessore è di 2.5 cm per la lunghezza inferiore a 120 cm (include 120 cm); lo spessore è di 3.0 cm per una lunghezza superiore a 120 cm e inferiore a 160 cm (include 160 cm); lo spessore è 3.3 cm per una lunghezza superiore a 170 cm (include 170 cm).
Per la larghezza di 90 cm, lo spessore è di 2.8 cm per la lunghezza inferiore a 120 cm (include 120 cm); lo spessore è 3.3 cm per una lunghezza superiore a 140 cm (include 140 cm).

Bei einer Breite von 70cm, 80 cm: Die Dicke beträgt 2.5 cm bei einer Länge unter 120 cm (einschließlich 120 cm); Die Dicke beträgt 3.0 cm bei einer Länge von über 120 cm und unter 160 cm (einschließlich 160 cm). Die Dicke beträgt 3.3 cm bei einer Länge von über 170 cm (einschließlich 170 cm).
Bei einer Breite von 90 cm: Die Dicke beträgt 2.8 cm bei einer Länge unter 120 cm (einschließlich 120 cm); Die Dicke beträgt 3.3 cm bei einer Länge von über 140 cm (einschließlich 140 cm).

Drain Position

Position de la bonde
Posizione di scarico
Position des Ablauf

A	C
70cm	17.25cm
80cm	22.25cm
80cm	27.25cm
100cm	32.75cm

D	E
5cm	25cm

F	G
9cm	22cm

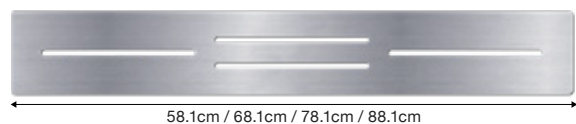
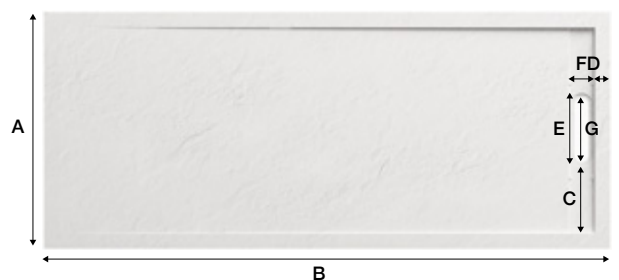

Thickness of cover : 2mm
Épaisseur de la grille: 2mm
Spessore del coperchio: 2mm
Dicke der Gitter: 2mm

Features

Caractéristiques
Caratteristiche
Eigenschaften

 **Anti-slip**
Antidérapante
Antiscivolo
Rutschfeste

 **Mass coloration**
Couleurs dans la masse
Massa colorata
In der Masse eingefärbt

 **Ecological material**
Matériau écologique
Materiale ecologico
Ökologisches Material

 **Antibacterial**
Antibactérien
Antibatterico
Antibakteriell

 **Waterproof**
Hydrofuge
Impermeabile
Wasserdicht

 **Easy to clean**
Nettoyage facile
Pulizia facile
Leicht zu reinigen

 **Cutttable**
Découpe
Tagliabile
Schneidbar

 **Optional colours**
Option couleurs
Colori Opzionali
Optionale Farben

 **Support repairs**
Réparable
Support repairs
Unterstützung von Reparaturen

 **5 years guarantee**
Garantie 5 ans
Garanzia 5 anni
5 Jahre Garantie

 **Include drainers**
Inclure bondes
Include piletta
Inkl. Abläufe

 **Include covers**
Inclure grilles
Include griglia
Inkl. Gitter



SERIE P

EN: A shower tray with an elegant central drain in polished stainless steel, also with lacquered option in the same colours as the tray, makes your shower room unique and vibrant.

FR: Un receveur de douche avec un élégant écoulement central en acier inoxydable poli, disposant également d'une option laquée dans les mêmes couleurs que le receveur, rend votre salle de douche unique et dynamique.

IT: Un piatto doccia con un elegante scarico centrale in acciaio inox lucidato, anche con opzione laccata negli stessi colori del piatto, rende il tuo bagno unico e vibrante.

DE: Eine Duschwanne mit einem eleganten zentralen Ablauf aus poliertem Edelstahl, auch mit lackierter Option in den gleichen Farben wie die Wanne, macht Ihr Duschzimmer einzigartig und lebendig.



DAYA

Code: Serie P
Texture: Stone Texture
Colours: White / Beige / Light Gray / Dark Gray / Black
Cover: Stainless steel grating as standard or optional painted grating

Article: Série P
Texture: Texture de pierre
Couleurs: Blanc / Crème / Ciment / Anthracite / Noir
Grille: Grille en inox de série ou grille peinte en option

Articolo: Serie P
Finiture: Trama di pietra
Colori: Bianco / Crema / Cemento / Antracite / Nero
Coperchio: Griglia in acciaio inox standard o griglia verniciata opzionale

Code: Serie P
Oberflächen: Stein Textur
Farben: Weiß / Beige / Hellgrau / Dunkelgrau / Schwarz
Gitter: Standardmäßiger Edelstahlgitter oder optional lackiertes Gitter



Serie P

Shower Tray

Receveur de douche
Piatti doccia
Duschwannen

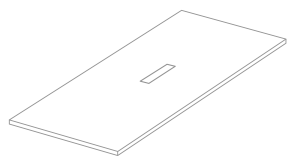

Length: 100-180 cm
Width: 70-80 cm
Height: 2.5 cm

Longueur: 100-180 cm
Largeur: 70-80 cm
Hauteur: 2.5 cm

Lunghezza: 100-180 cm
Larghezza: 70-80 cm
Altezza: 2.5 cm

Largo: 100-180 cm
Ancho: 70-80 cm
Höhe: 2.5 cm

Texture

Texture
Finiture
Oberflächen



Available Colours

Couleurs disponibles
Colori disponibili
Verfügbare Farben

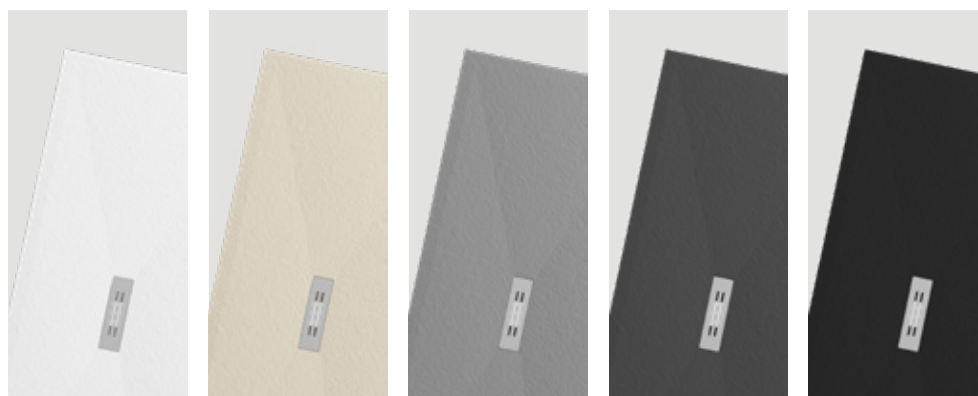

White
Blanc
Bianco
Weiß



Beige
Crème
Crema
Beige



Light Gray
Ciment
Cemento
Hellgrau



Dark Gray
Anthracite
Antracite
Dunkelgrau



Black
Noir
Nero
Schwarz

Cover

Grille
Griglia
Gitter



cover 10

Drainer

Bonde
Piletta
Ablauf



DY-611

The flow rate reaches 24 L/min.

Portata 24 litri al minuto.

Débit 24 litres par minute.

Die Durchflussrate erreicht 24 L / min.

DAYA

Code: Serie P
Texture: Stone Texture
Colours: White / Beige / Light Gray / Dark Gray / Black
Cover: Stainless steel grating as standard or optional painted grating

Article: Série P
Texture: Texture de pierre
Couleurs: Blanc / Crème / Ciment / Anthracite / Noir
Grille: Grille en inox de série ou grille peinte en option

Articolo: Serie P
Finiture: Trama di pietra
Colori: Bianco / Crema / Cemento / Antracite / Nero
Coperchio: Griglia in acciaio inox standard o griglia verniciata opzionale

Code: Serie P
Oberflächen: Stein Textur
Farben: Weiß / Beige / Hellgrau / Dunkelgrau / Schwarz
Gitter: Standardmäßiger Edelstahlgitter oder optional lackiertes Gitter



Serie P

Dimensions

Dimensions
Dimensioni
Abmessungen

	70cm	80cm
100cm	DY-T107P	DY-T108P
120cm	DY-T127P	DY-T128P
140cm	DY-T147P	DY-T148P
160cm	DY-T167P	DY-T168P
180cm	DY-T187P	DY-T188P

Thickness: 2.5cm
Épaisseur: 2.5cm
Grosor: 2.5cm
Thickness: 2.5cm



For other sizes,
please contact with the
sales department

En ce qui concerne les
autres tailles, il faut contacter
le service des ventes

Per altre dimensioni, si
prega di contattare il
reparto di vendita.

Für andere Größen
wenden Sie sich bitte an
die Verkaufsabteilung.

Drain Position

Position de la bonde
Posizione di scarico
Position des Ablauf

A	C
70cm	31cm
80cm	36cm

E	F
28.2cm	8cm

G
22cm

B	D
100cm	35.9cm
120cm	45.9cm
140cm	55.9cm
160cm	65.9cm
180cm	75.9cm

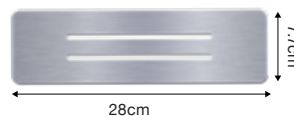
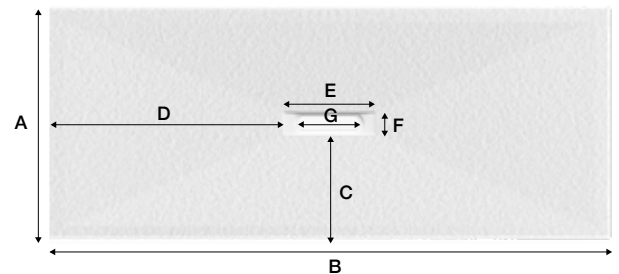

Thickness of cover : 2mm
Épaisseur de la grille: 2mm
Spessore del coperchio: 2mm
Dicke der Gitter: 2mm

Features

Caractéristiques
Caratteristiche
Eigenschaften



Anti-slip
Antidérapante
Antiscivolo
Rutschfeste



Mass coloration
Couleurs dans la masse
Massa colorata
In der Masse eingefärbt



Ecological material
Matériau écologique
Materiale ecologico
Ökologisches Material



Antibacterial
Antibactérien
Antibatterico
Antibakteriell



Waterproof
Hydrofuge
Impermeabile
Wasserdicht



Easy to clean
Nettoyage facile
Pulizia facile
Leicht zu reinigen



Cuttable
Découpe
Tagliabile
Schneidbar



Optional colours
Option couleurs
Colori Opzionali
Optionale Farben



Support repairs
Réparable
Support repairs
Unterstützung von Reparaturen



5 years guarantee
Garantie 5 ans
Garanzia 5 anni
5 Jahre Garantie



Include drainers
Inclure bonde
Inclure piletta
Inkl. Abläufe



Include covers
Inclure grilles
Inclure griglia
Inkl. Gitter



SERIE M

EN: With strong and well-defined lines, the M series perfectly suits the uniqueness of your bathroom, making the space more sophisticated as a result of the dynamic nature of its design.

IT: Con le linee decise e ben definite, la serie M si adatta perfettamente all'unicità del tuo bagno, rendendo lo spazio più sofisticato grazie al suo design di natura dinamica.

FR: Grâce à ses lignes fortes et bien définies, la série M convient parfaitement à l'unicité de votre salle de bains, rendant l'espace plus sophistiqué grâce à la nature dynamique de sa conception.

DE: Mit ihren starken und klar definierten Linien passt sich die Serie M perfekt an die Einzigartigkeit Ihres Badezimmers an und macht den Raum durch die dynamische Natur ihres Designs anspruchsvoller.

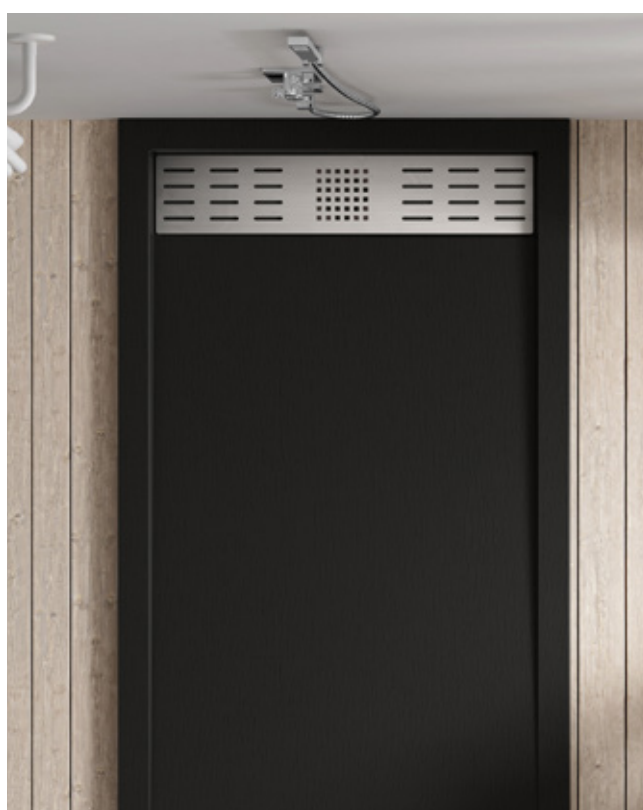

DAYA

Code: Serie M
Texture: Wooden Texture
Colours: White / Beige / Light Gray / Dark Gray / Black
Cover: Stainless steel grating as standard



Article: Série M
Texture: Texture du bois
Couleurs: Blanc / Crème / Ciment / Anthracite / Noir
Grille: Grille en inox de série ou grille peinte en option

Articolo: Serie M
Finiture: Struttura in Legno
Colori: Bianco / Crema / Cemento / Antracite / Nero
Coperchio: Griglia in acciaio inox standard o griglia verniciata opzionale

Code: Serie M
Oberflächen: Holzbeschaffenheit
Farben: Weiß / Beige / Hellgrau / Dunkelgrau / Schwarz
Gitter: Standardmäßiger Edstahlgitter oder optional lackiertes Gitter



Serie M

Shower Tray

Receveur de douche
Piatti doccia
Duschwannen

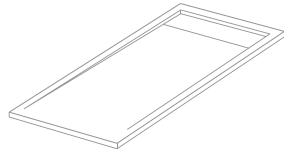

Length: 80-180 cm
Width: 70-90 cm
Height: 2.5/2.8/3.0/3.3 cm

Longueur: 80-180 cm
Largeur: 70-90 cm
Hauteur: 2.5/2.8/3.0/3.3 cm

Lunghezza: 80-180 cm
Larghezza: 70-90 cm
Altezza: 2.5/2.8/3.0/3.3 cm

Länge: 80-180 cm
Breite: 70-90 cm
Höhe: 2.5/2.8/3.0/3.3 cm

Texture

Texture
Finiture
Oberflächen



Available Colours

Couleurs disponibles
Colori disponibili
Verfügbare Farben

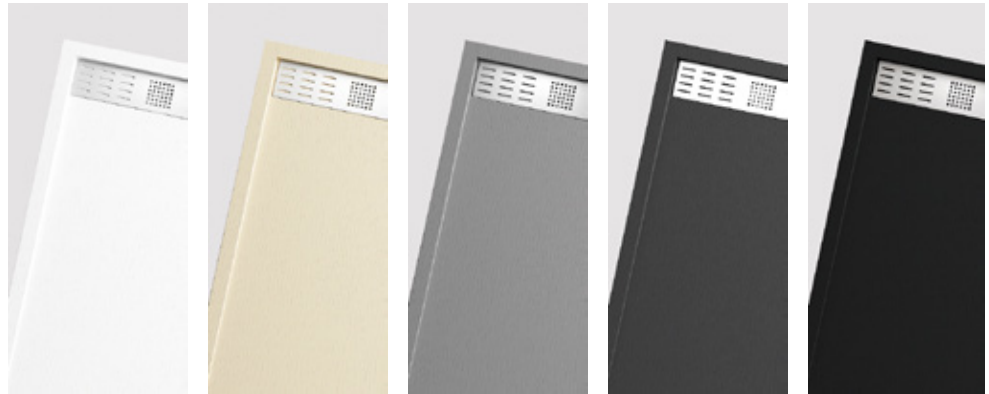

White
Blanc
Bianco
Weiß



Beige
Crème
Crema
Beige



Light Gray
Ciment
Cemento
Hellgrau



Dark Gray
Anthracite
Antracite
Dunkelgrau



Black
Noir
Nero
Schwarz

Cover

Grille
Griglia
Gitter



cover 7

Drainer

Bonde
Piletta
Ablauf



DY-11



DY-16



DY-132

The flow rate reaches 25.8 L/min.
Portata 25.8 litri al minuto.

Débit 25.8 litres par minute.
Die Durchflussrate erreicht 25.8 L / min.

DAYA

Code: Serie M
Texture: Wooden Texture
Colours: White / Beige / Light Gray / Dark Gray / Black
Cover: Stainless steel grating as standard

Article: Série M
Texture: Texture du bois
Couleurs: Blanc / Crème / Ciment / Anthracite / Noir
Grille: Grille en inox de série ou grille peinte en option

Articolo: Serie M
Finiture: Struttura in Legno
Colori: Bianco / Crema / Cemento / Antracite / Nero
Coperchio: Griglia in acciaio inox standard o griglia verniciata opzionale

Code: Serie M
Oberflächen: Holzbeschaffenheit
Farben: Weiß / Beige / Hellgrau / Dunkelgrau / Schwarz
Gitter: Standardmäßiger Edeltstahlgitter oder optional lackiertes Gitter



Serie M

Dimensions

Dimensions
Dimensioni
Abmessungen

	70cm	80cm	90cm
80cm		DY-T088M	
90cm			DY-T099M
100cm	DY-T107M	DY-T108M	
110cm	DY-T117M	DY-T118M	
120cm	DY-T127M	DY-T128M	
130cm	DY-T137M	DY-T138M	
140cm	DY-T147M	DY-T148M	DY-T149M
150cm	DY-T157M	DY-T158M	
160cm	DY-T167M	DY-T168M	
170cm	DY-T177M	DY-T178M	
180cm	DY-T187M	DY-T188M	



Thickness is 2.5cm for the length under 120cm (includes 120cm).
Thickness is 3.0cm for the length from 130cm to 160cm.
Thickness is 3.3cm for the length over 170cm.

Lo spessore è di 2.5 cm per la lunghezza inferiore a 120 cm (include 120 cm).
Lo spessore è di 3.0 cm per la lunghezza da 130 cm a 160 cm.
Lo spessore è di 3.3 cm per la lunghezza superiore a 170 cm.

Épaisseur est de 2.5 cm pour la longueur inférieure à 120 cm (y compris 120 cm).
Épaisseur est de 3.0 cm pour la longueur de 130 cm à 160 cm.
Épaisseur est de 3.3 cm pour la longueur supérieure à 170 cm.

Die Dicke beträgt 2.5 cm bei einer Länge unter 120 cm (einschließlich 120 cm).
Die Dicke beträgt 3.0 cm bei einer Länge von über 130 cm und unter 160 cm.
Die Dicke beträgt 3.3 cm bei einer Länge von über 170 cm.

Drain Position

Position de la bonde
Posizione di scarico
Position des Ablauf

A	C
70cm	24.2cm
80cm	29.2cm
90cm	34.2cm

E	F
9cm	13cm

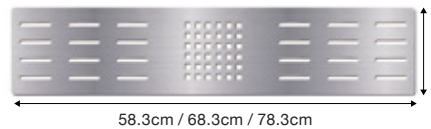

Thickness of cover : 2mm
Épaisseur de la grille: 2mm
Spessore del coperchio: 2mm
Dicke der Gitter: 2mm

Features

Caractéristiques
Caratteristiche
Eigenschaften



Anti-slip
Antidérapante
Antiscivolo
Rutschfeste



Mass coloration
Couleurs dans la masse
Massa colorata
In der Masse eingefärbt



Ecological material
Matériau écologique
Materiale ecologico
Ökologisches Material



Antibacterial
Antibactérien
Antibatterico
Antibakteriell



Waterproof
Hydrofuge
Impermeabile
Wasserdicht



Easy to clean
Nettoyage facile
Pulizia facile
Leicht zu reinigen



Cutable
Découpe
Tagliabile
Schneidbar



Optional colours
Option couleurs
Colori Opzionali
Optionale Farben



Support repairs
Réparable
Support repairs
Unterstützung von Reparaturen



5 years guarantee
Garantie 5 ans
Garanzia 5 anni
5 Jahre Garantie



Include drainers
Inclure bondes
Include piletta
Inkl. Abläufe



Include covers
Inclure grilles
Include griglia
Inkl. Gitter



SERIE

Q

EN: Q serie is a trendy shower tray with its middle cover and frame design, which admit ideal liquid over flow and watertightness. This modern shower tray brightens your shower room, giving you a luxury and comfortable atmosphere.

IT: La serie Q è un piatto doccia di tendenza con il design del griglia centrale e del telaio, che realizza la fuoriuscita del liquido ideale e la tenuta stagna. Questo piatto doccia moderno illumina il tuo bagno portandoti un'atmosfera lussuosa e confortevole.

FR: La série Q est un receveur de douche très tendance, avec son grille central et son cadre, qui permettent un écoulement idéal du liquide et une étanchéité parfaite. Ce receveur de douche moderne illumine votre salle de douche, vous assurant une atmosphère luxueuse et confortable.

DE: Die Q-Serie ist eine stilvolle Duschwanne mit einer mittleren Gitter und einem Rahmendesign, die einen idealen Flüssigkeitsüberlauf und Wasserdichtheit zulassen. Diese moderne Duschwanne erhellt Ihren Duschraum und sorgt für eine luxuriöse und komfortable Atmosphäre.



DAYA

Code: Serie Q
Texture: Slate Stone Texture
Colours: White / Beige / Light Gray / Dark Gray / Black
Cover: Stainless steel grating as standard or optional painted grating

Article: Série Q
Texture: Texture pierre ardoise
Couleurs: Blanc / Crème / Ciment / Anthracite / Noir
Grille: Grille en inox de série ou grille peinte en option

Articolo: Serie Q
Finiture: Pietra ardesia texture
Colori: Bianco / Crema / Cemento / Antracite / Nero
Coperchio: Griglia in acciaio inox standard o griglia verniciata opzionale

Code: Serie Q
Oberflächen: Holzbeschaffenheit
Farben: Weiß / Beige / Hellgrau / Dunkelgrau / Schwarz
Gitter: Standardmäßiger Edelstahlgitter oder optional lackiertes Gitter



Serie Q

Shower Tray

Receveur de douche
Piatti doccia
Duschwannen

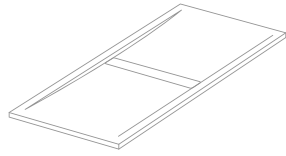

Length: 100-180 cm
Width: 70-80 cm
Height: 2.5 cm

Longueur: 100-180 cm
Largeur: 70-80 cm
Hauteur: 2.5 cm

Lunghezza: 100-180 cm
Larghezza: 70-80 cm
Altezza: 2.5 cm

Länge: 100-180 cm
Breite: 70-80 cm
Höhe: 2.5 cm

Texture

Texture
Finiture
Oberflächen



Available Colours

Couleurs disponibles
Colori disponibili
Verfügbare Farben

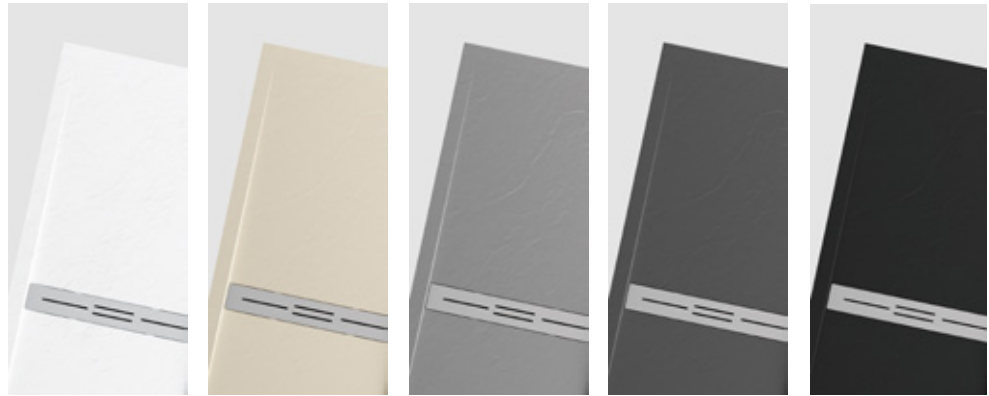

White
Blanc
Bianco
Weiß



Beige
Crème
Crema
Beige



Light Gray
Ciment
Cemento
Hellgrau



Dark Gray
Anthracite
Antracite
Dunkelgrau



Black
Noir
Nero
Schwarz

Cover

Grille
Griglia
Gitter



cover 9

Drainer

Bonde
Piletta
Ablauf



DY-611

The flow rate reaches 24 L/min.
Portata 24 litri al minuto.

Débit 24 litres par minute.
Die Durchflussrate erreicht 24 L / min.

DAYA

Code: Serie Q
Texture: Slate Stone Texture
Colours: White / Beige / Light Gray / Dark Gray / Black
Cover: Stainless steel grating as standard or optional painted grating

Article: Série Q
Texture: Texture pierre ardoise
Couleurs: Blanc / Crème / Ciment / Anthracite / Noir
Grille: Grille en inox de série ou grille peinte en option

Articolo: Serie Q
Finiture: Pietra ardesia texture
Colori: Bianco / Crema / Cemento / Antracite / Nero
Coperchio: Griglia in acciaio inox standard o griglia verniciata opzionale

Code: Serie Q
Oberflächen: Holzbeschaffenheit
Farben: Weiß / Beige / Hellgrau / Dunkelgrau / Schwarz
Gitter: Standardmäßiger Edelstahlgitter oder optional lackiertes Gitter

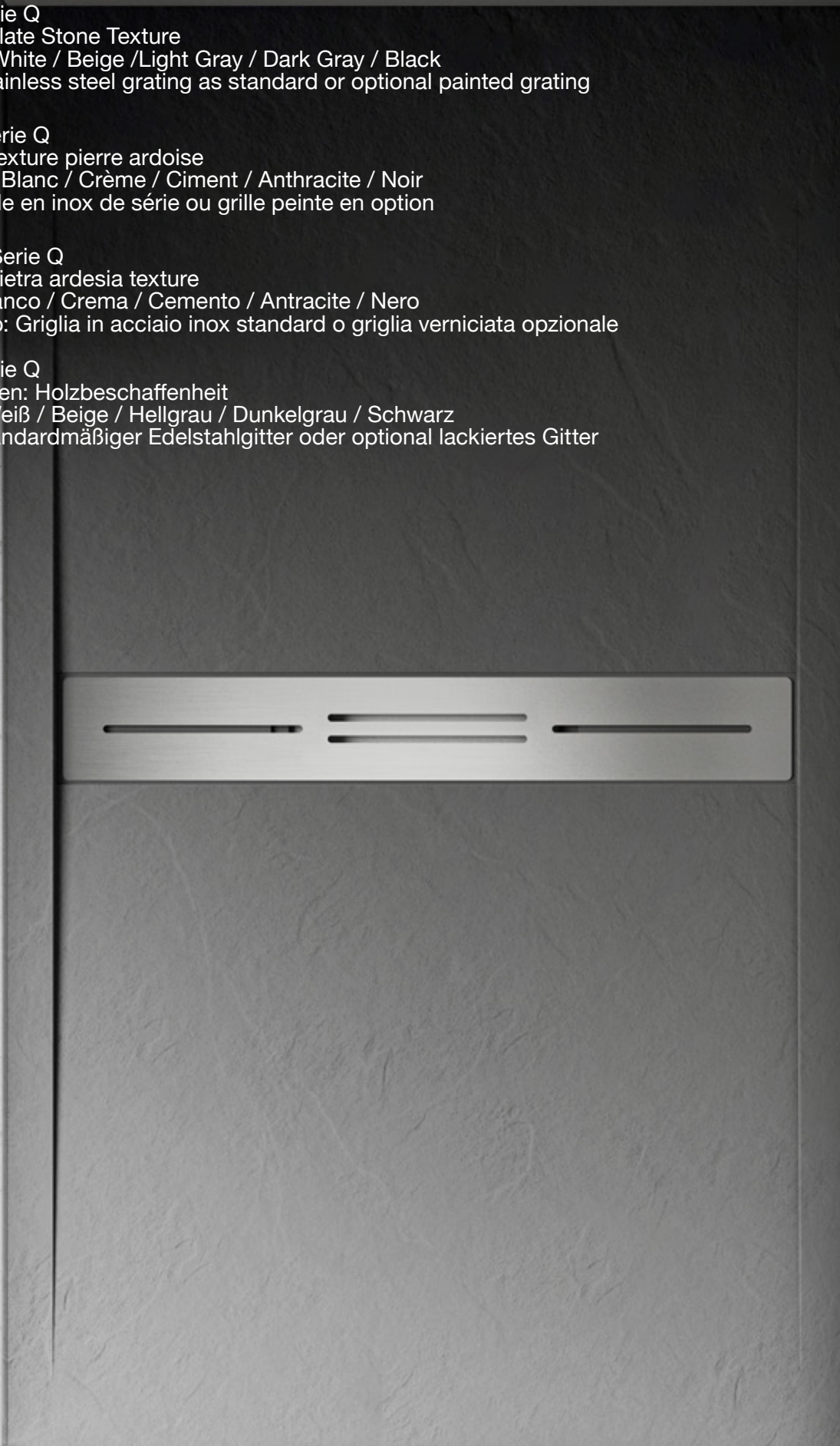

Serie Q

Dimensions

Dimensions
Dimensioni
Abmessungen

	70cm	80cm
100cm	DY-T107Q	DY-T108Q
120cm	DY-T127Q	DY-T128Q
140cm	DY-T147Q	DY-T148Q
160cm	DY-T167Q	DY-T168Q
180cm	DY-T187Q	DY-T188Q

Thickness: 2.5cm
Épaisseur: 2.5cm
Grosor: 2.5cm
Thickness: 2.5cm



For other sizes,
please contact with the
sales department

En ce qui concerne les
autres tailles, il faut contacter
le service des ventes

Per altre dimensioni, si
prega di contattare il
reparto di vendita.

Für andere Größen
wenden Sie sich bitte an
die Verkaufsabteilung.

Drain Position

Position de la bonde
Posizione di scarico
Position des Ablauf

A	C
70cm	60cm
80cm	70cm

E	F
25m	9cm

B	D
100cm	45.5cm
120cm	55.5cm
140cm	65.5cm
160cm	75.5cm
180cm	85.5cm

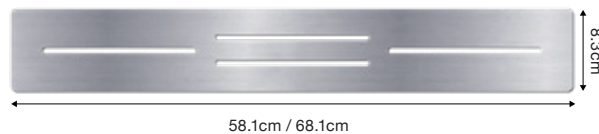
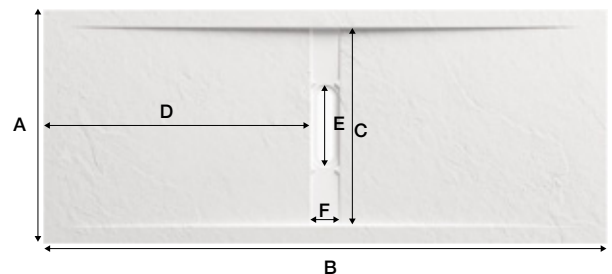

Thickness of cover : 2mm
Épaisseur de la grille: 2mm
Spessore del coperchio: 2mm
Dicke der Gitter: 2mm

Features

Caractéristiques
Caratteristiche
Eigenschaften



Anti-slip
Antidérapante
Antiscivolo
Rutschfeste



Mass coloration
Couleurs dans la masse
Massa colorata
In der Masse eingefärbt



Ecological material
Matériau écologique
Materiale ecologico
Ökologisches Material



Antibacterial
Antibactérien
Antibatterico
Antibakteriell



Waterproof
Hydrofuge
Impermeabile
Wasserdicht



Easy to clean
Nettoyage facile
Pulizia facile
Leicht zu reinigen



Cuttable
Découpe
Tagliabile
Schneidbar



Optional colours
Option couleurs
Colori Opzionali
Optionale Farben



Support repairs
Réparable
Support repairs
Unterstützung von Reparaturen



5 years guarantee
Garantie 5 ans
Garanzia 5 anni
5 Jahre Garantie



Include drainers
Inclure bondes
Inclure piletta
Inkl. Abläufe



Include covers
Inclure grilles
Inclure griglia
Inkl. Gitter



SERIE

S

EN: The product line series S takes the minimalistic approach of granite one step further. Its overflow drainage hides the drain from plain sight. The texture of the tray is homogeneous across the whole surface, this makes the natural feel of the granite an amazing experience for your senses.

IT: La linea di prodotti serie S porta l'approccio minimalista del granito un passo avanti. Il suo drenaggio a sfioro nasconde lo scarico alla vista. La trama del vassoio è omogenea su tutta la superficie, questo rende la sensazione naturale del granito un'esperienza straordinaria per i tuoi sensi.

FR: La gamme de produits de la série S va encore plus loin dans l'approche minimaliste du granit. Son drainage de trop-plein cache le drain de la vue. La texture du plateau est homogène sur toute la surface, ce qui fait de la sensation naturelle du granit une expérience incroyable pour vos sens.

DE: Die Produktlinie Serie S führt den minimalistischen Ansatz von Granit noch einen Schritt weiter. Seine Überlaufdrainage verbirgt den Abfluss vor den Augen. Die Textur des Tabletts ist über die gesamte Oberfläche homogen, dadurch wird die natürliche Haptik des Granits zu einem Erlebnis für Ihre Sinne.



DAYA

Code: Serie S
Texture: Granite Texture
Colours: White / Beige / Light Gray / Dark Gray / Black
Cover: Plastic cover

Article: Série S
Texture: Texture granit
Couleurs: Blanc / Crème / Ciment / Anthracite / Noir
Grille: Grille en plastique

Articolo: Serie S
Finiture: Texture di granito
Colori: Bianco / Crema / Cemento / Antracite / Nero
Coperchio: Griglia di plastica

Code: Serie S
Oberflächen: Granit
Farben: Weiß / Beige / Hellgrau / Dunkelgrau / Schwarz
Gitter: Gitter aus Kunststoff



Serie S

Shower Tray

Receveur de douche
Piatti doccia
Duschwannen

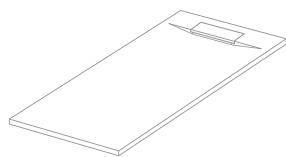

Length: 100-180 cm
Width: 70-80 cm
Height: 2.5 cm

Longueur: 100-180 cm
Largeur: 70-80 cm
Hauteur: 2.5 cm

Lunghezza: 100-180 cm
Larghezza: 70-80 cm
Altezza: 2.5 cm

Länge: 100-180 cm
Breite: 70-80 cm
Höhe: 2.5 cm

Texture

Texture
Finiture
Oberflächen



Available Colours

Couleurs disponibles
Colori disponibili
Verfügbare Farben

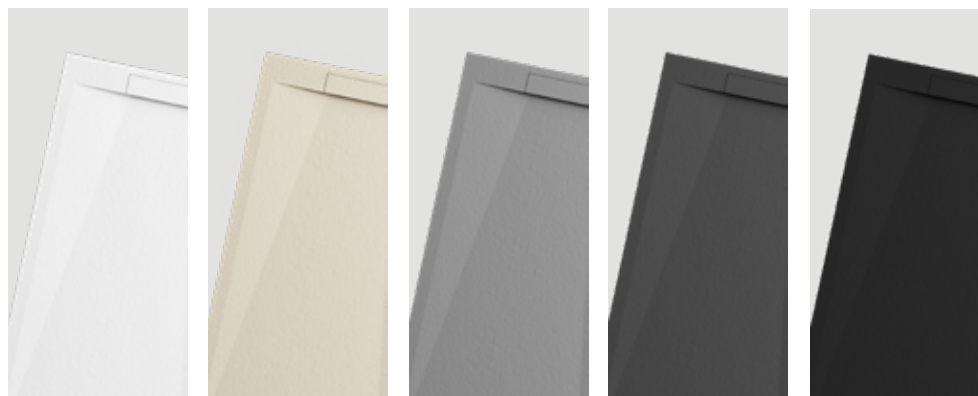

White
Blanc
Bianco
Weiß



Beige
Crème
Crema
Beige

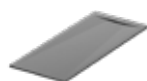

Light Gray
Ciment
Cemento
Hellgrau



Dark Gray
Anthracite
Antracite
Dunkelgrau



Black
Noir
Nero
Schwarz

Cover

Grille
Griglia
Gitter



Drainer

Bonde
Piletta
Ablauf



DY-611

The flow rate reaches 24 L/min.
Portata 24 litri al minuto.

Débit 24 litres par minute.
Die Durchflussrate erreicht 24 L / min.

DAYA

Code: Serie S
Texture: Granite Texture
Colours: White / Beige / Light Gray / Dark Gray / Black
Cover: Plastic cover

Article: Série S
Texture: Texture granit
Couleurs: Blanc / Crème / Ciment / Anthracite / Noir
Grille: Grille en plastique

Articolo: Serie S
Finiture: Texture di granito
Colori: Bianco / Crema / Cemento / Antracite / Nero
Coperchio: Griglia di plastica

Code: Serie S
Oberflächen: Granit
Farben: Weiß / Beige / Hellgrau / Dunkelgrau / Schwarz
Gitter: Gitter aus Kunststoff



Serie S

Dimensions

Dimensions
Dimensioni
Abmessungen

	70cm	80cm
100cm	DY-T107S	DY-T108S
120cm	DY-T127S	DY-T128S
140cm	DY-T147S	DY-T148S
160cm	DY-T167S	DY-T168S
180cm	DY-T187S	DY-T188S

Thickness: 2.5cm
Épaisseur: 2.5cm
Grosor: 2.5cm
Thickness: 2.5cm

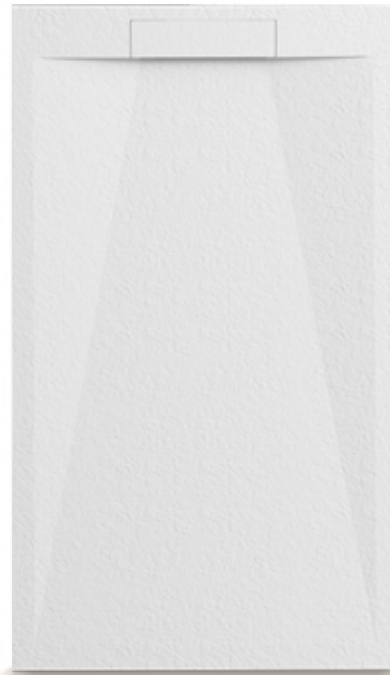

For other sizes,
please contact with the
sales department

En ce qui concerne les
autres tailles, il faut contacter
le service des ventes

Per altre dimensioni, si
prega di contattare il
reparto di vendita.

Für andere Größen
wenden Sie sich bitte an
die Verkaufsabteilung.

Drain Position

Position de la bonde
Posizione di scarico
Position des Ablauf

A	C
70cm	20cm
80cm	25cm

D	E
8cm	22cm

F	G
3cm	30cm

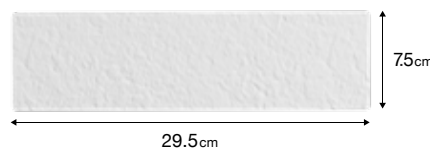
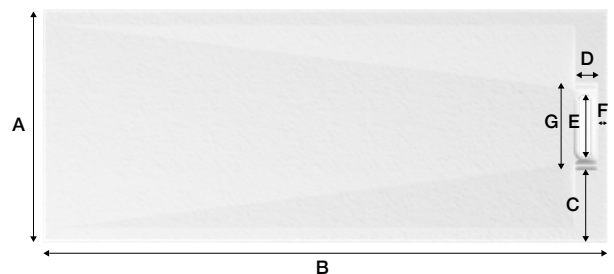

Thickness of cover : 6mm
Épaisseur de la grille: 6mm
Spessore del coperchio: 6mm
Dicke der Gitter: 6mm

Features

Caractéristiques
Caratteristiche
Eigenschaften

 **Anti-slip**
Antidérapante
Antiscivolo
Rutschfeste

 **Mass coloration**
Couleurs dans la masse
Massa colorata
In der Masse eingefärbt

 **Ecological material**
Matériau écologique
Materiale ecologico
Ökologisches Material

 **Antibacterial**
Antibactérien
Antibatterico
Antibakteriell

 **Waterproof**
Hydrofuge
Impermeabile
Wasserdicht

 **Easy to clean**
Nettoyage facile
Pulizia facile
Leicht zu reinigen

 **Cutttable**
Découpe
Tagliabile
Schneidbar

 **Optional colours**
Option couleurs
Colori Opzionali
Optionale Farben

 **Support repairs**
Réparable
Support repairs
Unterstützung von Reparaturen

 **5 years guarantee**
Garantie 5 ans
Garanzia 5 anni
5 Jahre Garantie

 **Include drainers**
Inclure bondes
Include piletta
Inkl. Abläufe

 **Include covers**
Inclure grilles
Include griglia
Inkl. Gitter



SERIE

L

EN: This model is characterised by its special tilt, allowing easy and rapid drainage. The position of the grill and the frame situated at the front give it a modern and exclusive appearance.

IT: Questo modello è caratterizzato dalla sua speciale inclinazione che consente uno scolo facile e rapido. La posizione della griglia e il telaio situato nella parte anteriore offrono un aspetto moderno ed esclusivo.

FR: Ce modèle est caractérisé par son inclinaison spéciale, permettant un drainage facile et rapide. Le positionnement de la grille et le cadre situé à l'avant lui confèrent un aspect moderne et exclusif.

DE: Dieses Modell zeichnet sich durch eine spezielle Neigung aus, die eine einfache und schnelle Entwässerung ermöglicht. Die Position des Gitters und der an der Vorderseite befindliche Rahmen verleihen ihm ein modernes und einzigartiges Aussehen.



DAYA

Code: Serie L
Texture: Slate Stone Texture
Colours: White / Beige / Light Gray / Dark Gray / Black
Cover: Plastic cover

Article: Série L
Texture: Texture pierre ardoise
Couleurs: Blanc / Crème / Ciment / Anthracite / Noir
Grille: Grille en plastique

Articolo: Serie L
Finiture: Pietra ardesia texture
Colori: Bianco / Crema / Cemento / Antracite / Nero
Coperchio: Griglia di plastica

Code: Serie L
Oberflächen: Holzbeschaffenheit
Farben: Weiß / Beige / Hellgrau / Dunkelgrau / Schwarz
Gitter: Gitter aus Kunststoff



Serie L

Shower Tray

Receveur de douche
Piatti doccia
Duschwannen

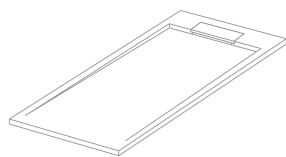

Length: 80-180 cm
Width: 70-90 cm
Height: 2.5 cm

Longueur: 80-180 cm
Largeur: 70-90 cm
Hauteur: 2.5 cm

Lunghezza: 80-180 cm
Larghezza: 70-90 cm
Altezza: 2.5 cm

Länge: 80-180 cm
Breite: 70-90 cm
Höhe: 2.5 cm

Texture

Texture
Finiture
Oberflächen

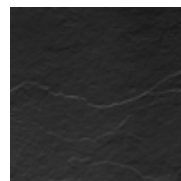
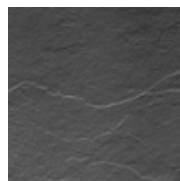
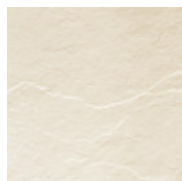
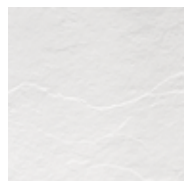

Available Colours

Couleurs disponibles
Colori disponibili
Verfügbare Farben

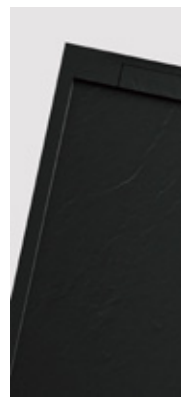
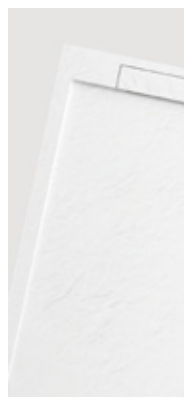

White
Blanc
Bianco
Weiß



Beige
Crème
Crema
Beige



Light Gray
Ciment
Cemento
Hellgrau



Dark Gray
Anthracite
Antracite
Dunkelgrau



Black
Noir
Nero
Schwarz

Cover

Grille
Griglia
Gitter



Drainer

Bonde
Piletta
Ablauf



DY-611

The flow rate reaches 24 L/min.
Portata 24 litri al minuto.

Débit 24 litres par minute.
Die Durchflussrate erreicht 24 L / min.

DAYA

Code: Serie L
Texture: Slate Stone Texture
Colours: White / Beige / Light Gray / Dark Gray / Black
Cover: Plastic cover

Article: Série L
Texture: Texture pierre ardoise
Couleurs: Blanc / Crème / Ciment / Anthracite / Noir
Grille: Grille en plastique

Articolo: Serie L
Finiture: Pietra ardesia texture
Colori: Bianco / Crema / Cemento / Antracite / Nero
Coperchio: Griglia di plastica

Code: Serie L
Oberflächen: Holzbeschaffenheit
Farben: Weiß / Beige / Hellgrau / Dunkelgrau / Schwarz
Gitter: Gitter aus Kunststoff



Serie L

Dimensions

Dimensions
Dimensioni
Abmessungen

	70cm	80cm	90cm
80cm		DY-T088L	
90cm	DY-T097L		DY-T099L
100cm	DY-T107L	DY-T108L	
120cm	DY-T127L	DY-T128L	DY-T129L
130cm			DY-T139L
140cm	DY-T147L	DY-T148L	DY-T149L
150cm	DY-T157L	DY-T158L	
160cm	DY-T167L	DY-T168L	DY-T169L
170cm	DY-T177L	DY-T178L	
180cm	DY-T187L	DY-T188L	

Thickness: 2.5cm
Épaisseur: 2.5cm
Grosor: 2.5cm
Thickness: 2.5cm



For other sizes,
please contact with the
sales department

En ce qui concerne les
autres tailles, il faut contacter
le service des ventes

Per altre dimensioni, si
prega di contattare il
reparto di vendita.

Für andere Größen
wenden Sie sich bitte an
die Verkaufsabteilung.

Drain Position

Position de la bonde
Posizione di scarico
Position des Ablauf

A	C
70cm	20cm
80cm	25cm
90cm	30cm

D	E
8cm	22cm

F	G
3cm	30cm



Thickness of cover : 6mm
Épaisseur de la grille: 6mm
Spessore del coperchio: 6mm
Dicke der Gitter: 6mm

Features

Caractéristiques
Caratteristiche
Eigenschaften



Anti-slip
Antidérapante
Antiscivolo
Rutschfeste



Mass coloration
Couleurs dans la masse
Massa colorata
In der Masse eingefärbt



Ecological material
Matériau écologique
Materiale ecologico
Ökologisches Material



Antibacterial
Antibactérien
Antibatterico
Antibakteriell



Waterproof
Hydrofuge
Impermeabile
Wasserdicht



Easy to clean
Nettoyage facile
Pulizia facile
Leicht zu reinigen



Cuttable
Découpe
Tagliabile
Schneidbar



Optional colours
Option couleurs
Colori Opzionali
Optionale Farben



Support repairs
Réparable
Support repairs
Unterstützung von Reparaturen



5 years guarantee
Garantie 5 ans
Garanzia 5 anni
5 Jahre Garantie



Include drainers
Inclure bondes
Include piletta
Inkl. Abläufe



Include covers
Inclure grilles
Include griglia
Inkl. Gitter



SERIE N

EN: Good design and accessibility are the keys to this shower tray with a minimalist and delicate look. A shower tray with hidden drain designed to solve any architectural obstacle.

FR: Une bonne conception et une accessibilité aisée sont les clés de ce receveur de douche à l'allure minimaliste et délicate. Un receveur de douche avec un drain caché destiné à résoudre tout obstacle architectural.

IT: Buon design e accessibilità sono le chiavi di questo piatto doccia con un aspetto minimalista e delicato. Un piatto doccia con scarico nascosto progettato per risolvere qualche ostacolo architettonico.

DE: Ausgezeichnetes Design und Zugänglichkeit sind der Schlüssel zur Einfachheit und Raffinesse dieser Duschwanne. Eine Duschwanne mit verstecktem Ablauf design löst jedes architektonische Hindernis.



DAYA

Code: Serie N
Texture: Wooden Texture
Colours: White / Beige / Light Gray / Dark Gray / Black
Cover: Stainless steel grating as standard

Article: Série N
Texture: Texture du bois
Couleurs: Blanc / Crème / Ciment / Anthracite / Noir
Grille: Grille en inox de série ou grille peinte en option

Articolo: Serie N
Finiture: Struttura in Legno
Colori: Bianco / Crema / Cemento / Antracite / Nero
Coperchio: Griglia in acciaio inox standard o griglia verniciata opzionale

Code: Serie N
Oberflächen: Holzbeschaffenheit
Farben: Weiß / Beige / Hellgrau / Dunkelgrau / Schwarz
Gitter: Standardmäßiger Edstahlgitter oder optional lackiertes Gitter



Serie N

Shower Tray

Receveur de douche
Piatti doccia
Duschwannen

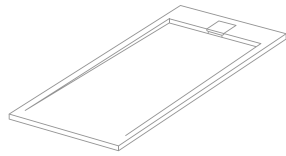

Length: 100-180 cm
Width: 70-80 cm
Height: 2.5 cm

Longueur: 100-180 cm
Largeur: 70-80 cm
Hauteur: 2.5 cm

Lunghezza: 100-180 cm
Larghezza: 70-80 cm
Altezza: 2.5 cm

Länge: 100-180 cm
Breite: 70-80 cm
Höhe: 2.5 cm

Texture

Texture
Finiture
Oberflächen



Available Colours

Couleurs disponibles
Colori disponibili
Verfügbare Farben

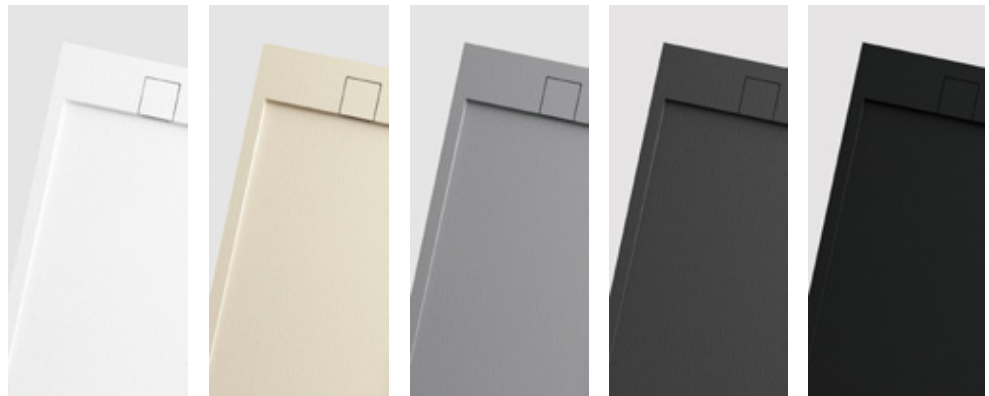

White
Blanc
Bianco
Weiß



Beige
Crème
Crema
Beige



Light Gray
Ciment
Cemento
Hellgrau



Dark Gray
Anthracite
Antracite
Dunkelgrau



Black
Noir
Nero
Schwarz

Cover

Grille
Griglia
Gitter



Drainer

Bonde
Piletta
Ablauf



DY-11



DY-16



DY-132

The flow rate reaches 25.8 L/min.
Portata 25.8 litri al minuto.

Débit 25.8 litres par minute.
Die Durchflussrate erreicht 25.8 L / min.

DAYA

Code: Serie N
Texture: Wooden Texture
Colours: White / Beige / Light Gray / Dark Gray / Black
Cover: Stainless steel grating as standard

Article: Série N
Texture: Texture du bois
Couleurs: Blanc / Crème / Ciment / Anthracite / Noir
Grille: Grille en inox de série ou grille peinte en option

Articolo: Serie N
Finiture: Struttura in Legno
Colori: Bianco / Crema / Cemento / Antracite / Nero
Coperchio: Griglia in acciaio inox standard o griglia verniciata opzionale

Code: Serie N
Oberflächen: Holzbeschaffenheit
Farben: Weiß / Beige / Hellgrau / Dunkelgrau / Schwarz
Gitter: Standardmäßiger Edstahlgitter oder optional lackiertes Gitter



Serie N

Dimensions

Dimensions
Dimensioni
Abmessungen

	70cm	80cm
100cm	DY-T107N	DY-T108N
120cm	DY-T127N	DY-T128N
140cm	DY-T147N	DY-T148N
160cm	DY-T167N	DY-T168N
170cm	DY-T177N	
180cm	DY-T187N	DY-T188N

Thickness: 2.5cm
Épaisseur: 2.5cm
Grosor: 2.5cm
Thickness: 2.5cm



For other sizes,
please contact with the
sales department

En ce qui concerne les
autres tailles, il faut contacter
le service des ventes

Per altre dimensioni, si
prega di contattare il
reparto di vendita.

Für andere Größen
wenden Sie sich bitte an
die Verkaufsabteilung.

Drain Position

Position de la bonde
Posizione di scarico
Position des Ablauf

A	C
70cm	28.25cm
80cm	33.25cm

D	E
16.5cm	9cm

F
13.5cm

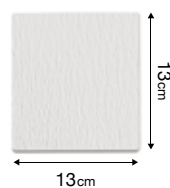
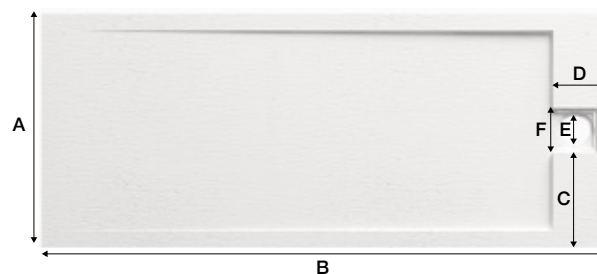

Thickness of cover : 6mm
Épaisseur de la grille: 6mm
Spessore del coperchio: 6mm
Dicke der Gitter: 6mm

Features

Caractéristiques
Caratteristiche
Eigenschaften



Anti-slip
Antidérapante
Antiscivolo
Rutschfeste



Mass coloration
Couleurs dans la masse
Massa colorata
In der Masse eingefärbt



Ecological material
Matériau écologique
Materiale ecologico
Ökologisches Material



Antibacterial
Antibactérien
Antibatterico
Antibakteriell



Waterproof
Hydrofuge
Impermeabile
Wasserdicht



Easy to clean
Nettoyage facile
Pulizia facile
Leicht zu reinigen



Cuttable
Découpe
Tagliabile
Schneidbar



Optional colours
Option couleurs
Colori Opzionali
Optionale Farben



Support repairs
Réparable
Support repairs
Unterstützung von Reparaturen



5 years guarantee
Garantie 5 ans
Garanzia 5 anni
5 Jahre Garantie



Include drainers
Inclure bondes
Inclure piletta
Inkl. Abläufe



Include covers
Inclure grilles
Inclure griglia
Inkl. Gitter



SERIE **K**

EN: At the request of market trends, this model is presented as a new version of the conventional shower tray due to its hidden drain, achieving an up-to-date minimalism bathroom.

IT: In base alla richiesta della tendenza del mercato, questo modello rappresenta una nuova versione del piatto doccia convenzionale grazie al suo scarico nascosto, realizzando un bagno moderno e minimalista.

FR: Pour répondre aux tendances du marché, ce modèle est présenté comme une nouvelle version du receveur de douche conventionnel grâce à son écoulement caché, permettant ainsi d'obtenir une salle de bains minimaliste et moderne.

DE: Auf Wunsch der Markttrends wird dieses Modell aufgrund seines versteckten Ablauf als eine neue Version der herkömmlichen Duschwanne präsentiert, wodurch ein zeitgemäßes minimalistisches Badezimmer erreicht wird.



DAYA

Code: Serie K
Texture: Granite Texture
Colours: White / Beige / Light Gray / Dark Gray / Black
Cover: Plastic cover

Article: Série K
Texture: Texture granit
Couleurs: Blanc / Crème / Ciment / Anthracite / Noir
Grille: Grille en plastique

Articolo: Serie K
Finiture: Texture di granito
Colori: Bianco / Crema / Cemento / Antracite / Nero
Coperchio: Griglia di plastica

Code: Serie K
Oberflächen: Granit
Farben: Weiß / Beige / Hellgrau / Dunkelgrau / Schwarz
Gitter: Gitter aus Kunststoff



Serie K

Shower Tray

Receveur de douche
Piatti doccia
Duschwannen

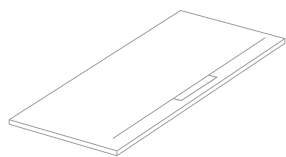

Length: 100-180 cm
Width: 70-80 cm
Height: 2.5 cm

Longueur: 100-180 cm
Largeur: 70-80 cm
Hauteur: 2.5 cm

Lunghezza: 100-180 cm
Larghezza: 70-80 cm
Altezza: 2.5 cm

Länge: 100-180 cm
Breite: 70-80 cm
Höhe: 2.5 cm

Texture

Texture
Finiture
Oberflächen

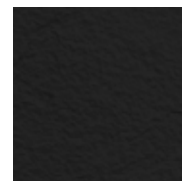
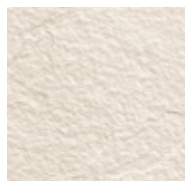

Available Colours

Couleurs disponibles
Colori disponibili
Verfügbare Farben

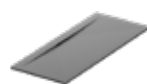

White
Blanc
Bianco
Weiß

Beige
Crème
Crema
Beige

Light Gray
Ciment
Cemento
Hellgrau

Dark Gray
Anthracite
Antracite
Dunkelgrau

Black
Noir
Nero
Schwarz

Cover

Grille
Griglia
Gitter



Drainer

Bonde
Piletta
Ablauf



DY-611

The flow rate reaches 24 L/min.
Portata 24 litri al minuto.

Débit 24 litres par minute.
Die Durchflussrate erreicht 24 L / min.

DAYA

Code: Serie K
Texture: Granite Texture
Colours: White / Beige / Light Gray / Dark Gray / Black
Cover: Plastic cover

Article: Série K
Texture: Texture granit
Couleurs: Blanc / Crème / Ciment / Anthracite / Noir
Grille: Grille en plastique

Articolo: Serie K
Finiture: Texture di granito
Colori: Bianco / Crema / Cemento / Antracite / Nero
Coperchio: Griglia di plastica

Code: Serie K
Oberflächen: Granit
Farben: Weiß / Beige / Hellgrau / Dunkelgrau / Schwarz
Gitter: Gitter aus Kunststoff

Serie K

Dimensions

Dimensions
Dimensioni
Abmessungen

	70cm	80cm
100cm	DY-T107K	DY-T108K
120cm	DY-T127K	DY-T128K
140cm	DY-T147K	DY-T148K
160cm	DY-T167K	DY-T168K
180cm	DY-T187K	DY-T188K

Thickness: 2.5cm
Épaisseur: 2.5cm
Grosor: 2.5cm
Thickness: 2.5cm



For other sizes,
please contact with the
sales department

En ce qui concerne les
autres tailles, il faut contacter
le service des ventes

Per altre dimensioni, si
prega di contattare il
reparto di vendita.

Für andere Größen
wenden Sie sich bitte an
die Verkaufsabteilung.

Drain Position

Position de la bonde
Posizione di scarico
Position des Ablauf

C	D	E
11cm	30cm	3cm

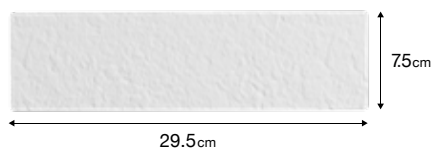
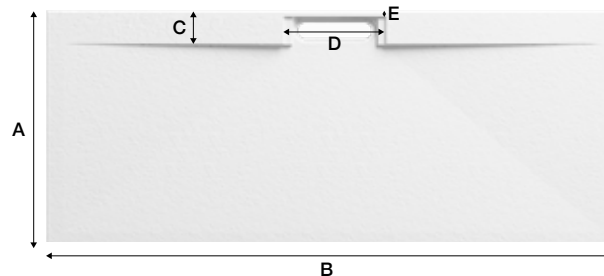

Thickness of cover : 6mm
Épaisseur de la grille: 6mm
Spessore del coperchio: 6mm
Dicke der Gitter: 6mm

Features

Caractéristiques
Caratteristiche
Eigenschaften



Anti-slip
Antidérapante
Antiscivolo
Rutschfeste



Mass coloration
Couleurs dans la masse
Massa colorata
In der Masse eingefärbt



Ecological material
Matériau écologique
Materiale ecologico
Ökologisches Material



Antibacterial
Antibactérien
Antibatterico
Antibakteriell



Waterproof
Hydrofuge
Impermeabile
Wasserdicht



Easy to clean
Nettoyage facile
Pulizia facile
Leicht zu reinigen



Cuttable
Découpe
Tagliabile
Schneidbar



Optional colours
Option couleurs
Colori Opzionali
Optionale Farben



Support repairs
Réparable
Support repairs
Unterstützung von Reparaturen



5 years guarantee
Garantie 5 ans
Garanzia 5 anni
5 Jahre Garantie



Include drainers
Inclure bondes
Include piletta
Inkl. Abläufe



Include covers
Inclure grilles
Include griglia
Inkl. Gitter

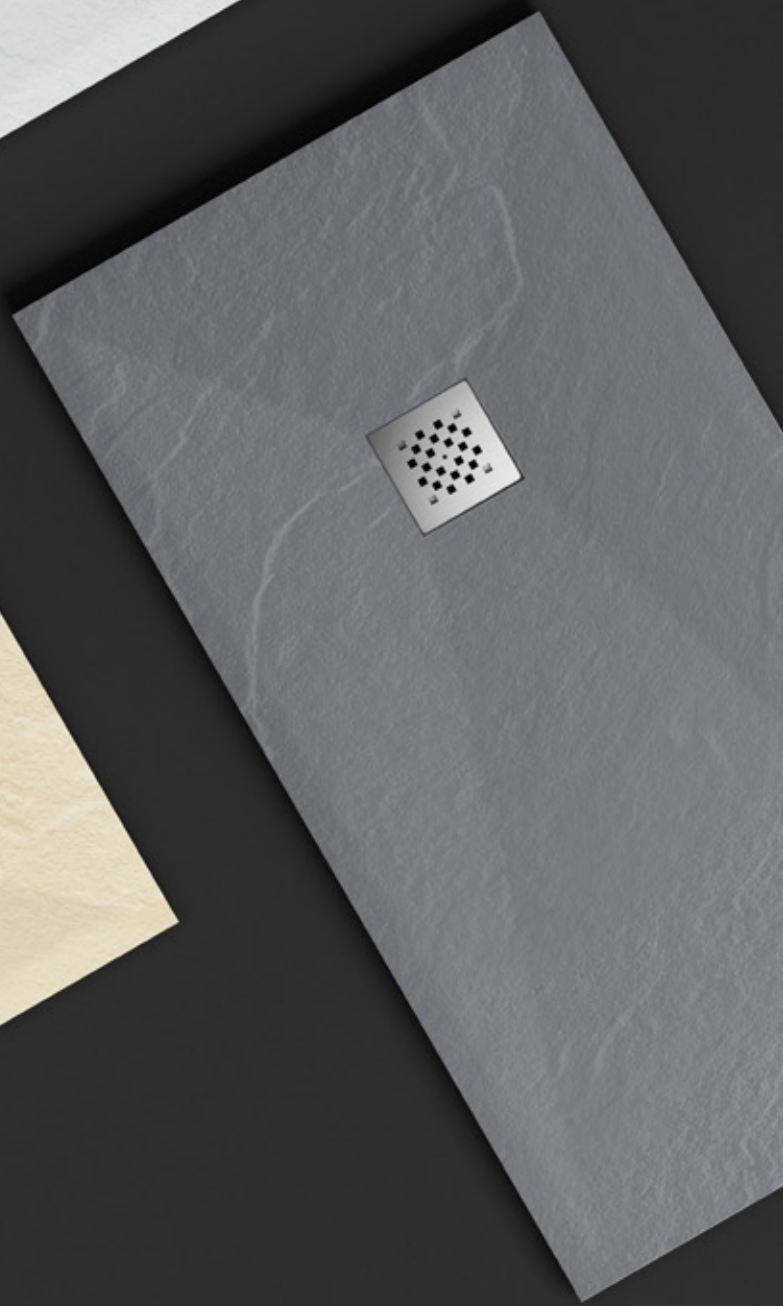

SERIE

G

EN: This product is a kind of new material, which is made of a compounds of fiber glass and reinforced material with gelcoat on the surface. One of the lightest shower trays on the market with excellent bearing effect, stable performance and long usage time.

IT: Questo prodotto è un tipo realizzato con nuovi materiali, cioè di un composto di fibra di vetro e materiale rinforzato con gelcoat sulla superficie. Uno di questi piatti doccia più leggeri sul mercato con un effetto portante eccellente, prestazioni stabili e tempo di uso prolungato.

FR: Fabriqué à partir d'un mélange de fibre de verre et de matériau renforcé avec un gel coat en surface, ce produit est l'un des receveurs de douche les plus légers du marché, avec un excellent effet de palier, des performances stables et une longue durée d'utilisation.

DE: Bei diesem Produkt handelt es sich um eine Art neues Material, das aus einer Verbindung von Glasfaser und verstärktem Material mit Gelcoat auf der Oberfläche besteht. Eine der leichtesten Duschwannen auf dem Markt mit ausgezeichneter Lagerwirkung, stabiler Leistung und langer Nutzungsdauer.

Material

Matériel
Materiale
Material



Fiberglass Material
Matériau en fibre de verre
Materiale in fibra di vetro
Glasfaser-Material

Features

Caractéristiques
Caratteristiche
Eigenschaften



Single Operating
Fonctionnement unique
Funzionamento singolo
Einzelbetrieb



Higer Solidhardness
Dureté supérieure
Durezza solida più alta
Höhere Feststoffhärte



Better Utilization
Meilleure utilisation
Migliore utilizzo
Bessere Nutzung

Theoretical weight

Poids théorique
Peso teorico
Theoretisches Gewicht

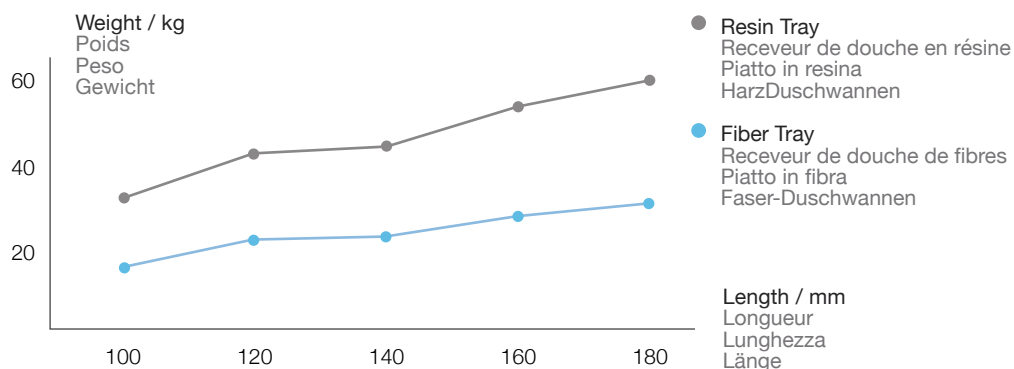

	100cm	110cm	120cm	130cm	140cm	150cm	160cm	170cm	180cm
70cm	14.46 kg	15.80kg	17.35kg	18.80kg	20.25kg	21.69kg	23.14 kg	24.20kg	25.80kg
80cm	16.53kg	17.90kg	19.83kg	21.20kg	23.14kg	24.50kg	26.44kg	28.10kg	29.50kg

DAYA

Code: Serie G
Texture: Slate Stone Texture
Colours: White / Beige / Light Gray / Dark Gray / Black
Cover: Stainless steel grating as standard or optional painted grating

Article: Série G
Texture: Texture pierre ardoise
Couleurs: Blanc / Crème / Ciment / Anthracite / Noir
Grille: Grille en inox de série ou grille peinte en option

Articolo: Serie G
Finiture: Pietra ardesia texture
Colori: Bianco / Crema / Cemento / Antracite / Nero
Coperchio: Griglia in acciaio inox standard o griglia verniciata opzionale

Code: Serie G
Oberflächen: Schieferstein-Textur
Farben: Weiß / Beige / Hellgrau / Dunkelgrau / Schwarz
Gitter: Standardmäßiger Edelstahlgitter oder optional lackiertes Gitter



Serie G

Shower Tray

Receveur de douche
Piatti doccia
Duschwannen

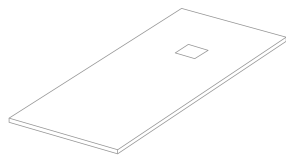

Length: 100-180 cm
Width: 70-80 cm
Height: 2.5/3.5 cm

Longueur: 100-180 cm
Largeur: 70-80 cm
Hauteur: 2.5/3.5 cm

Lunghezza: 100-180 cm
Larghezza: 70-80 cm
Altezza: 2.5/3.5 cm

Länge: 100-180 cm
Breite: 70-80 cm
Höhe: 2.5/3.5 cm

Texture

Texture
Finiture
Oberflächen

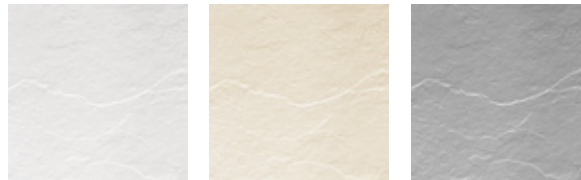

Available Colours

Couleurs disponibles
Colori disponibili
Verfügbare Farben

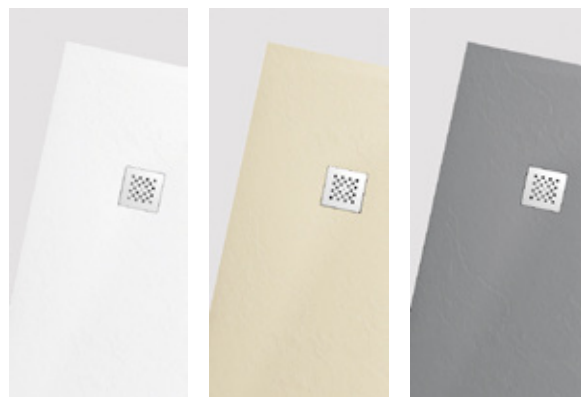

White
Blanc
Bianco
Weiß



Beige
Crème
Crema
Beige



Light Gray
Ciment
Cemento
Hellgrau

Cover

Grille
Griglia
Gitter

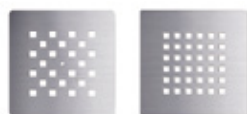

DY-1

DY-2



DY-2
white

DY-2
beige

DY-2
light gray

- ★ Optional cover is supplied in the same colour as the shower tray.

La grille en option est livrée dans la même couleur que le receveur.

Il griglia opzionale è fornito nello stesso colore del piatto doccia.

Die optionale Gitter wird in der gleichen Farbe wie die Duschwanne geliefert.

Drainer

Bonde
Piletta
Ablauf



DY-11



DY-16



DY-132

The flow rate reaches 25.8 L/min.
Portata 25.8 litri al minuto.

Débit 25.8 litres par minute.
Die Durchflussrate erreicht 25.8 L / min.

DAYA

Code: Serie G
Texture: Slate Stone Texture
Colours: White / Beige / Light Gray / Dark Gray / Black
Cover: Stainless steel grating as standard or optional painted grating

Article: Série G
Texture: Texture pierre ardoise
Couleurs: Blanc / Crème / Ciment / Anthracite / Noir
Grille: Grille en inox de série ou grille peinte en option

Articolo: Serie G
Finiture: Pietra ardesia texture
Colori: Bianco / Crema / Cemento / Antracite / Nero
Coperchio: Griglia in acciaio inox standard o griglia verniciata opzionale

Code: Serie G
Oberflächen: Schieferstein-Textur
Farben: Weiß / Beige / Hellgrau / Dunkelgrau / Schwarz
Gitter: Standardmäßiger Edstahlgitter oder optional lackiertes Gitter



Serie G

Dimensions

Dimensions
Dimensioni
Abmessungen

	70cm	80cm
100cm	DY-T107G	DY-T108G
110cm	DY-T117G	DY-T118G
120cm	DY-T127G	DY-T128G
130cm	DY-T137G	DY-T138G
140cm	DY-T147G	DY-T148G
150cm	DY-T157G	DY-T158G
160cm	DY-T167G	DY-T168G
170cm	DY-T177G	DY-T178G
180cm	DY-T187G	DY-T188G

Thickness: 2.5-3.5cm
Épaisseur: 2.5-3.5cm
Grosor: 2.5-3.5cm
Thickness: 2.5-3.5cm

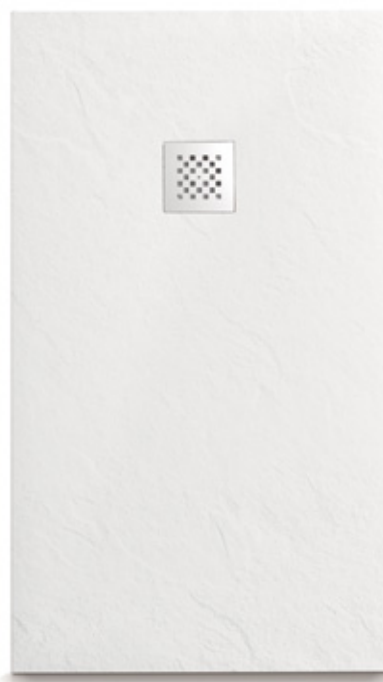

For other sizes,
please contact with the
sales department

En ce qui concerne les
autres tailles, il faut contacter
le service des ventes

Per altre dimensioni, si
prega di contattare il
reparto di vendita.

Für andere Größen
wenden Sie sich bitte an
die Verkaufsabteilung.

Drain Position

Position de la bonde
Posizione di scarico
Position des Ablauf

A	C
70cm	35cm
80cm	40cm

B	D
≥150cm	43cm
≤140cm	31cm

E	F
9cm	13.5cm

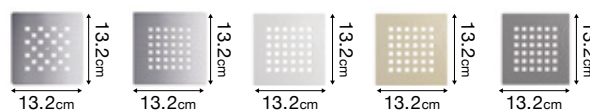

Thickness of cover : 1.2mm Épaisseur de la grille: 1.2mm Spessore del coperchio:1.2mm Dicke der Gitter: 1.2mm

Features

Caractéristiques
Caratteristiche
Eigenschaften

 **Anti-slip**
Antidérapante
Antiscivolo
Rutschfeste

 **Mass coloration**
Couleurs dans la masse
Massa colorata
In der Masse eingefärbt

 **Ecological material**
Matériau écologique
Materiale ecologico
Ökologisches Material

 **Antibacterial**
Antibactérien
Antibatterico
Antibakteriell

 **Waterproof**
Hydrofuge
Impermeabile
Wasserdicht

 **Easy to clean**
Nettoyage facile
Pulizia facile
Leicht zu reinigen

 **Cutttable**
Découpe
Tagliabile
Schneidbar

 **Include covers**
Inclure grilles
Include griglia
inkl. Gitter

 **5 years guarantee**
Garantie 5 ans
Garanzia 5 anni
5 Jahre Garantie

 **Include drainers**
Inclure bondes
Include piletta
Inkl. Abläufe

 **Support repairs**
Réparable
Support repairs
Unterstützung von Reparaturen

DY-132

Optional drains Bondes en option · Piletta opzionali · Optionale Abläufe

Drainer

Bonde
Piletta
Ablauf

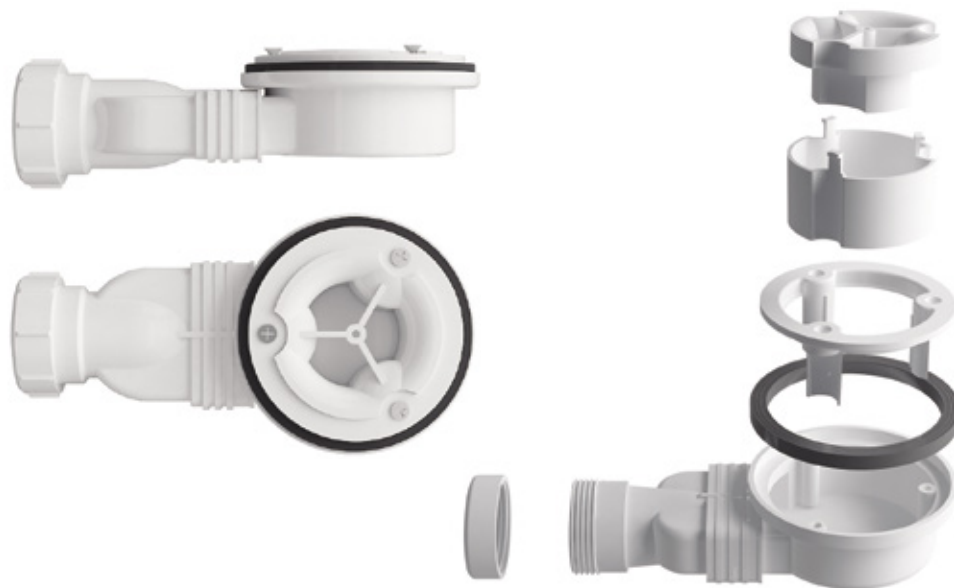

Dimension

Dimensions
Dimensione
Abmessungen

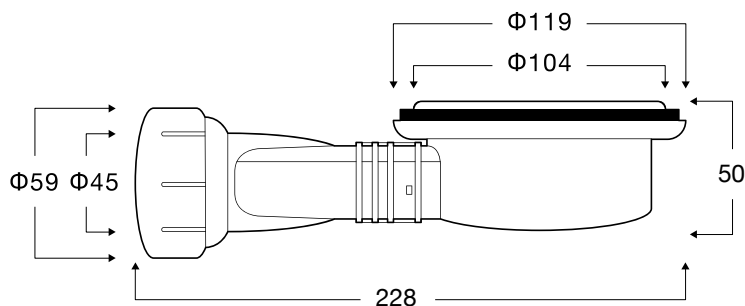

Measurements in mm
Mesures en mm
Misura in mm
Maße in mm

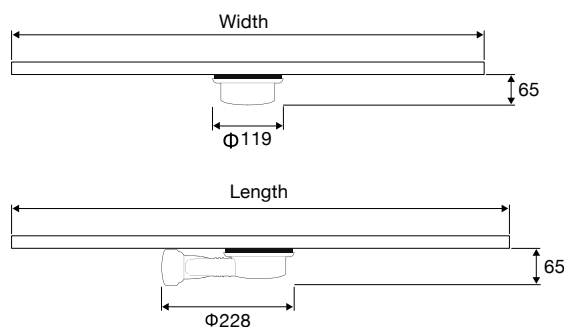

Applicable shower tray

Receveur de douche applicable
Piatto doccia applicabile
Anwendbare Duschwanne

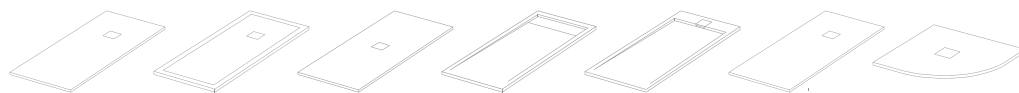

Series F	Series I	Series O	Series M	Series N	Series G	Series FQ
Série F	Série I	Série O	Série M	Série N	Série G	Série FQ
Serie F	Serie I	Serie O	Serie M	Serie N	Serie G	Serie FQ
Serie F	Serie I	Serie O	Serie M	Serie N	Serie G	Serie FQ

Flow rate

Débit
Portata
Durchflussrate

The flow rate reaches 25.8 L/min.

Débit 25.8 litres par minute.

Portata 25.8 litri al minuto.

Die Durchflussrate erreicht 25.8 L / min.

DY-11

Optional drains Bondes en option · Piletta opzionali · Optionale Abläufe

Drainer

Bonde
Piletta
Ablauf

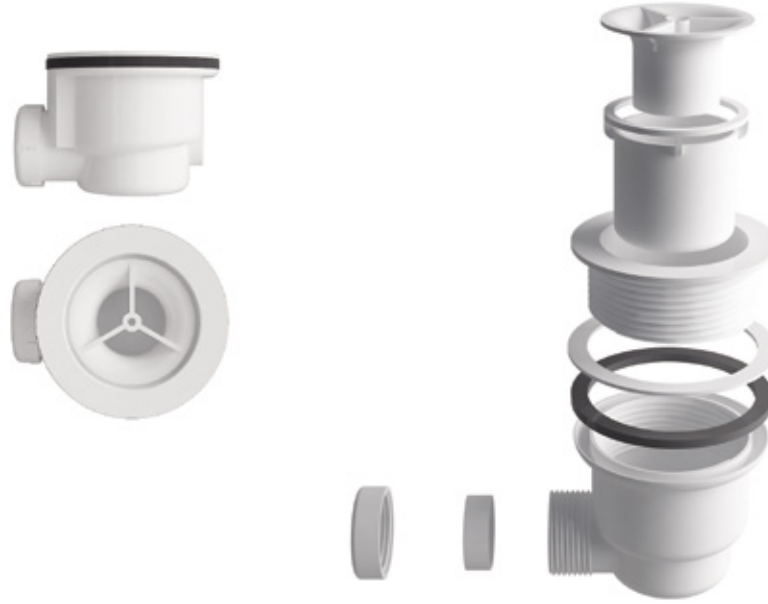

Dimension

Dimensions
Dimensione
Abmessungen

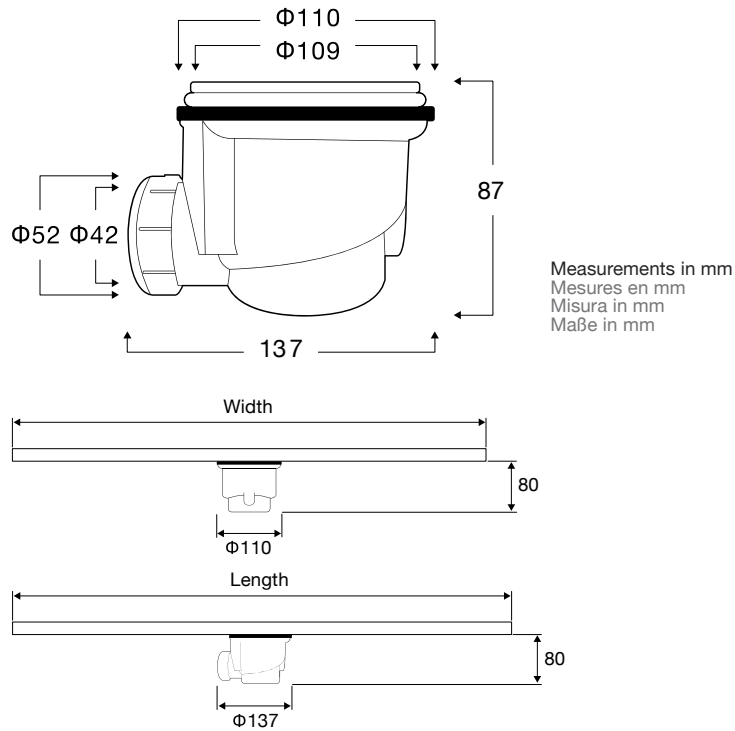

Applicable shower tray

Receveur de douche applicable
Piatto doccia applicabile
Anwendbare Duschwanne

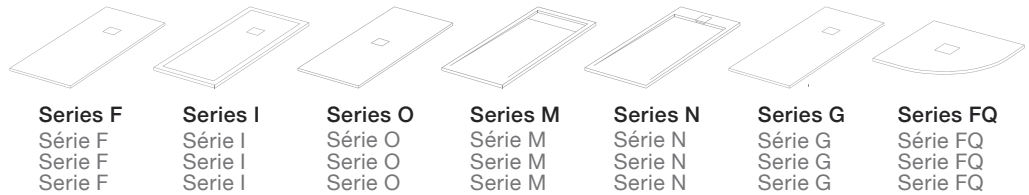

Flow rate

Débit
Portata
Durchflussrate

The flow rate reaches 25.2 L/min.
Débit 25.2 litres par minute.
Portata 25.2 litri al minuto.
Die Durchflussrate erreicht 25.2 L / min.

DY-16

Optional drains Bondes en option · Piletta opzionali · Optionale Abläufe

Drainer

Bonde
Piletta
Ablauf

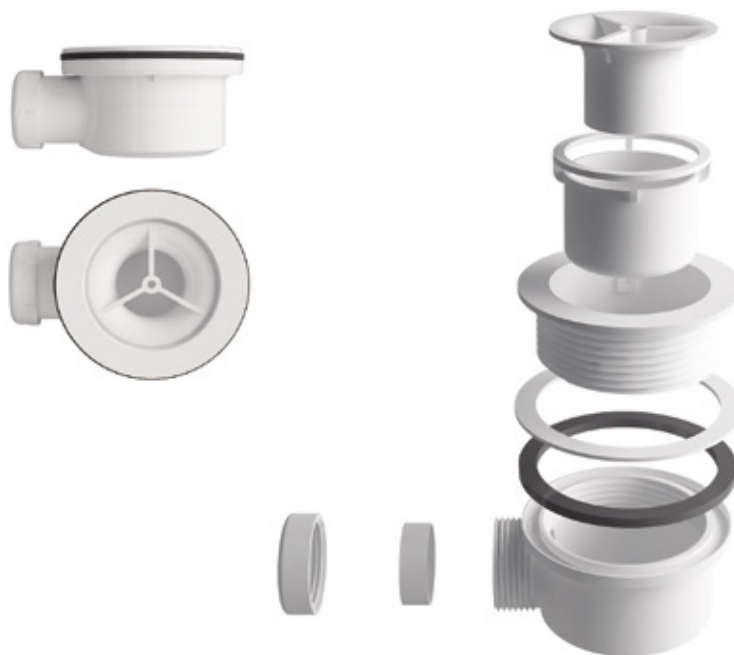

Dimension

Dimensions
Dimensione
Abmessungen

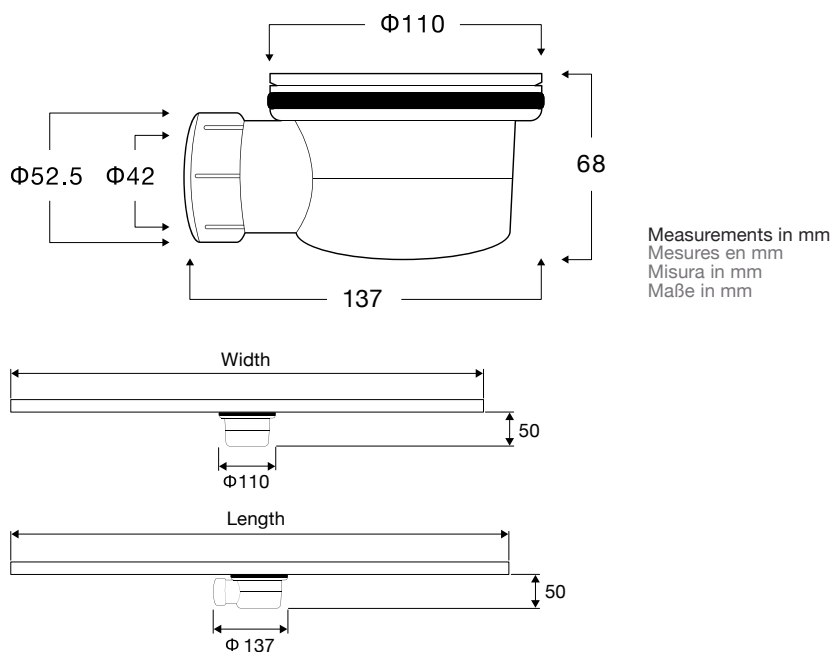

Applicable shower tray

Receveur de douche applicable
Piatto doccia applicabile
Anwendbare Duschwanne

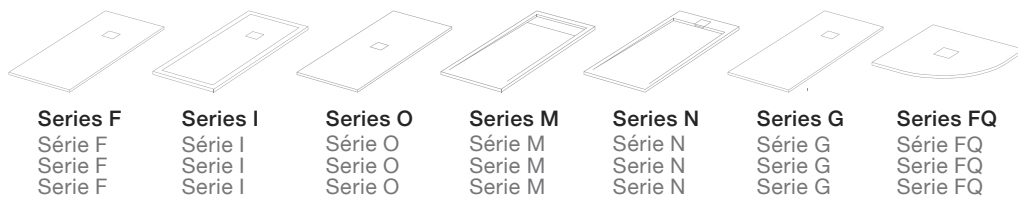

Flow rate

Débit
Portata
Durchflussrate

The flow rate reaches 25.8 L/min.
Débit 25.8 litres par minute.
Portata 25.8 litri al minuto.
Die Durchflussrate erreicht 25.8 L / min.

DY-611

Optional drains Bondes en option · Piletta opzionali · Optionale Abläufe

Drainer

Bonde
Piletta
Ablauf

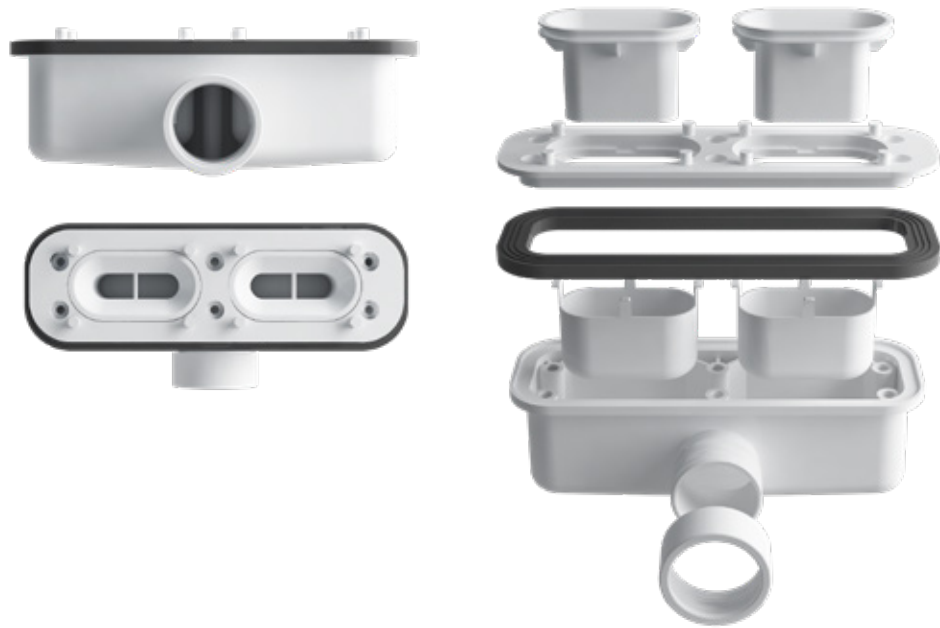

Dimension

Dimensions
Dimensione
Abmessungen

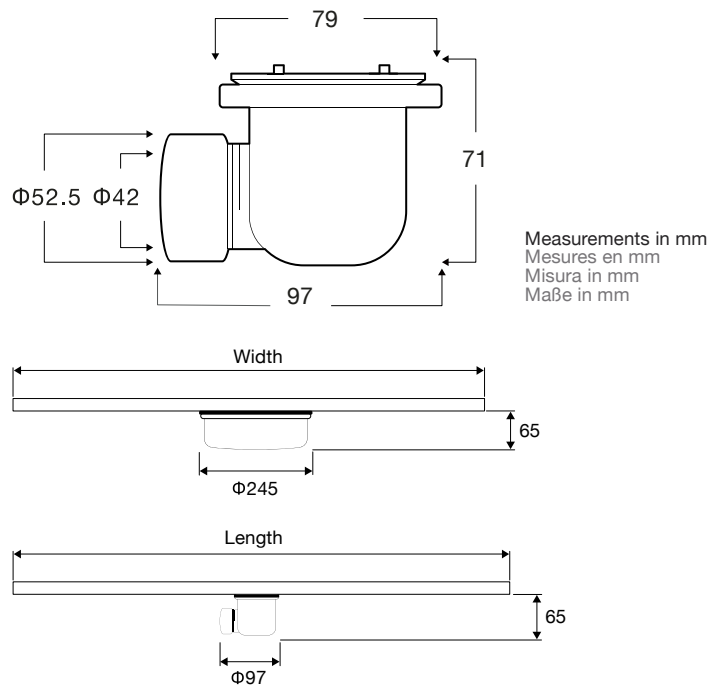

Applicable shower tray

Receveur de douche applicable
Piatto doccia applicabile
Anwendbare Duschwanne

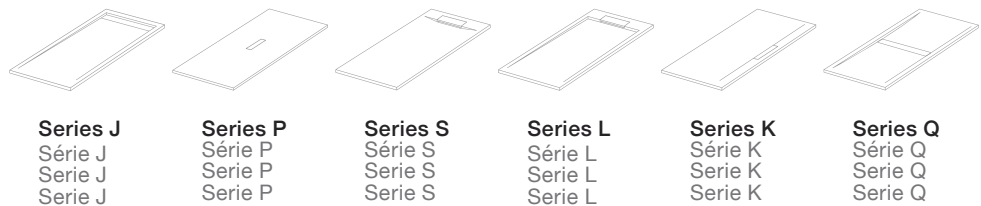

Flow rate

Débit
Portata
Durchflussrate

The flow rate reaches 24 L/min.
Débit 24 litres par minute.
Portata 24 litri al minuto.
Die Durchflussrate erreicht 24 L / min.

INSTALLATION INSTRUCTION

INSTRUCTION D'INSTALLATION · ISTRUZIONI PER L'INSTALLAZIONE · INSTALLATIONSANLEITUNG

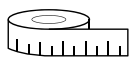

Measuring Tape
Mètre ruban
Nasto di misurazione
Maßband

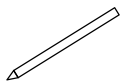

Pencil
Crayon
Matita
Bleistift

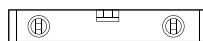

Spirit Level
Niveau à bulle
Livello di spirito
Wasserwaage



Trowel
Truelle
Spatola
Kelle

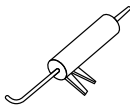

Adhesive
Adhésive
Adesivo
Klebstoff



Masking Tape
Ruban adhésif
Nastro adesivo
Abdeckband



Cement and Fine Sand
Ciment et sable fin
Cemento e Sabbia Fine
Zement und Feinsand

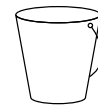

Bucket
Seau
Secchio
Eimer

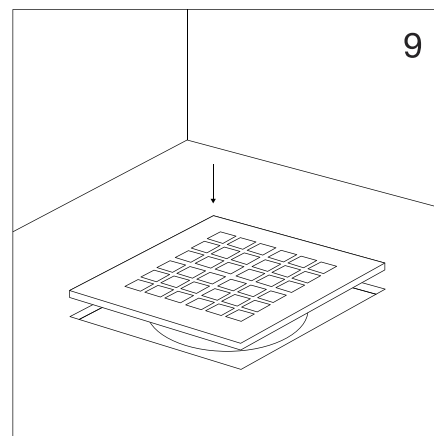
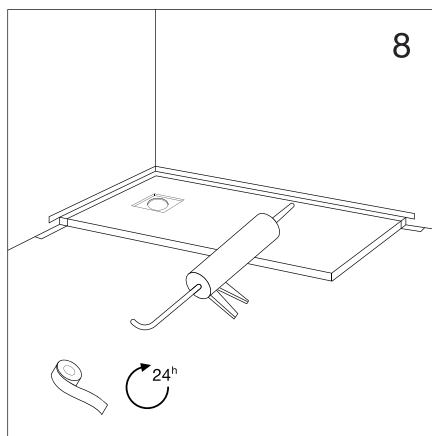
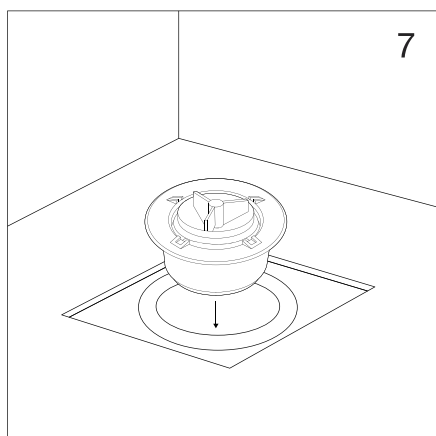
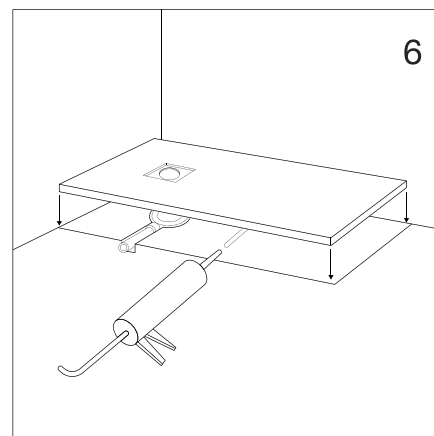
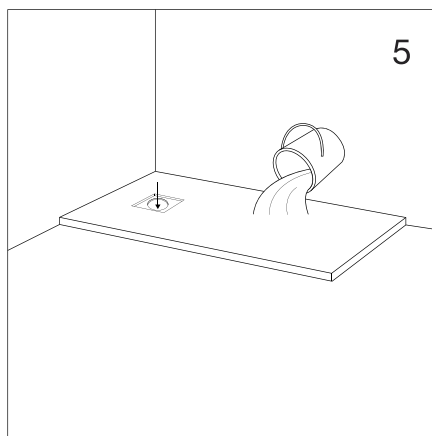
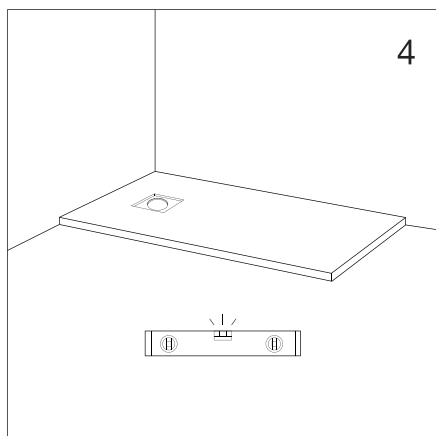
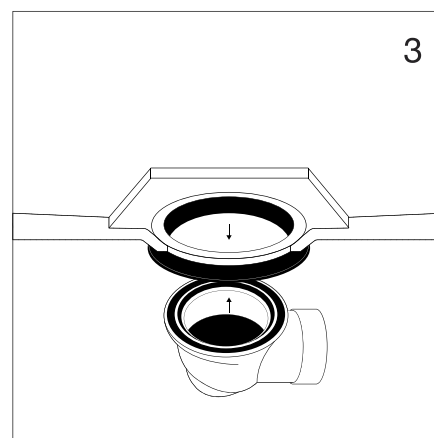
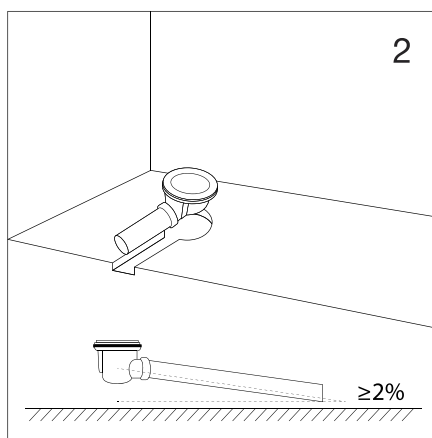
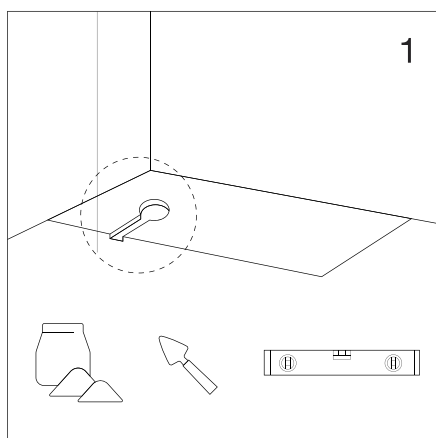

EN: Remove the protective covering in the area around the plug hole, and on the sides where the tray will meet the wall. Make sure the correct fittings are attached to the top of the waste pipe and secure the waste fittings around the plughole of the shower tray.

If you are installing the tray directly onto the floor, line it up over the waste trap to make sure it fits into place. Outline the edge of the tray with your pencil – this will help you to determine where to spread the mortar.

If your shower tray kit included a wall sealant strip, secure it to the tray at the sides where it meets the wall. If not, use your caulking gun and apply a thin layer of silicone to create a watertight seal along the edge of the tray.

Remove the rest of the plastic covering and secure the waste outlet to the trap, according to the manufacturer guidelines. This may be something you can simply tighten into place from above, or you may have to navigate from beneath the tray in order to secure the fittings.

If your shower tray kit included a wall sealant strip, secure it to the tray at the sides where it meets the wall. If not, use your caulking gun and apply a thin layer of silicone to create a watertight seal along the edge of the tray.

IT: Rimuovere il griglia protettivo nell'area intorno al foro del tappo e sui lati in cui il piatto raggiungerà il muro. Assicurarsi che i raccordi corretti siano collegati alla parte superiore del tubo di rifiuti e fissare i raccordi di scarico intorno al foro del tappo del piatto doccia.

Se stai installando il piatto direttamente sul pavimento, allinealo sul sifone dei rifiuti per garantire che si adatti a posizione. Delinea il bordo del piatto con la matita - questo ti aiuterà a decidere dove stendere la malta.

Se il tuo kit del piatto doccia include una striscia sigillante per muro, fissala al piatto ai lati dove raggiunge il muro. Altrimenti, utilizza la pistola per calafataggio e applica uno strato sottile di silicone per creare una tenuta stagna lungo il bordo del piatto.

Rimuovere il resto del griglia plastica e fissare l'uscita dei rifiuti al sifone, secondo le linee guida del produttore. Questo potrebbe essere qualcosa che puoi semplicemente stringere in posizione dall'alto, oppure dovrete per forza navigare da sotto il piatto per fissare i raccordi.

Se il tuo kit del piatto doccia include una striscia sigillante per muro, fissala al piatto ai lati dove raggiunge il muro. Altrimenti, usa la tua pistola per calafataggio e applica uno strato sottile di silicone per creare una tenuta stagna lungo il bordo del piatto.

FR: Veuillez enlever le revêtement de protection dans la zone autour du trou de la prise et sur les côtés où le plateau rencontrera le mur. Vous devez vous assurer que les bons raccords sont fixés sur le dessus du tuyau d'évacuation et fixer les raccords d'évacuation autour du trou de la bonde du receveur de douche.

Dans le cas où vous installez le plateau directement sur le sol, il faut l'aligner sur la trappe à déchets pour s'assurer qu'il est bien en place. Avec votre crayon, marquez le bord du plateau - cela vous permettra de déterminer où étaler le mortier.

Au cas où votre kit de receveur de douche comprendrait une bande d'étanchéité murale, fixez-la au receveur sur les côtés où elle rencontre le mur. Autrement, utilisez votre pistolet à calfeutrer et appliquez une fine couche de silicone pour créer un joint étanche le long du bord du receveur.

Veuillez enlever le reste du plastique et fixer la sortie des déchets au piège, en respectant les directives du fabricant. Vous pouvez tout simplement le serrer en place par le haut, ou vous devrez peut-être naviguer sous le plateau pour sécuriser les raccords.

Au cas où votre kit de receveur de douche comprendrait une bande d'étanchéité murale, fixez-la au receveur sur les côtés où elle touche le mur. Autrement, servez-vous de votre pistolet à calfeutrer et appliquez une fine couche de silicone pour créer un joint étanche le long du bord du receveur.

DE: Entfernen Sie die Schutzgitter im Bereich um das Stopfenloch und an den Seiten, an denen die Wanne Kontakt mit der Wand hat. Stellen Sie sicher, dass die Armaturen richtig an der Oberseite des Abflussrohrs angebracht sind. Befestigen Sie die Ablaufgarnituren um das Abflussloch der Duschwanne herum.

Wenn Sie die Duschwannen direkt auf dem Boden installieren, richten Sie sie über dem Abfallsammler aus, um sicherzustellen, dass sie an Ort und Stelle installiert ist. Umreißen Sie den Rand der Wanne mit Ihrem Bleistift - Auf diese Weise können Sie feststellen, wo der Mörtel verteilt werden soll.

Wenn Ihr Duschwannenset eine Wanddichtung enthält, befestigen Sie sie an der Seite, an der sie Kontakt mit der Wand hat. Falls nicht, verwenden Sie eine Fugenpistole und tragen Sie eine dünne Silikonschicht auf, um eine wasserdichte Abdichtung entlang des Randes der duschwannen zu schaffen.

Entfernen Sie den Rest der Kunststoffabdeckung und befestigen Sie den Abfallauslass an der Wanne gemäß den Richtlinien des Herstellers. Sie können es einfach von oben festziehen oder von unterhalb der Wanne navigieren, um die Beschläge zu sichern.

Wenn Ihr Duschwannenset eine Wanddichtung enthält, befestigen Sie sie an der Seite, an der sie Kontakt mit der Wand hat. Falls nicht, verwenden Sie eine Fugenpistole und tragen Sie eine dünne Silikonschicht auf, um eine wasserdichte Abdichtung entlang des Randes der duschwannen zu schaffen.

INSTRUCTION FOR USE OF REPAIR KIT

INSTRUCTION D'UTILISATION DU KIT DE RÉPARATION · ISTRUZIONI PER L'USO DEL KIT DI RIPARAZIONE
GEBRAUCHSANWEISUNG DES REPARATUR KITS

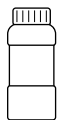

Gel-coat (200mL)
Gel-coat (200mL)
Gel-coat (200mL)
Gelcoat (200 ml)



Curing agent (15mL)
Agent de durcissement (15mL)
Agente di stagionatura (15mL)
Härter (15 ml)

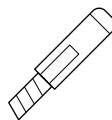

Scraper
Grattoir
Raschietto
Spatel

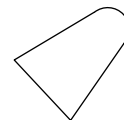

Scraping Plate
Grattoir en plastique
Piastra raschiante
Schaberplatte

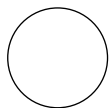

Sandpaper (320µm)
Papier ponce (320µm)
Carta vetrata (320µm)
Schleifpapier (320 µm)

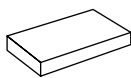

Foamed Block
Bloc mousse
Blocco di schiuma
Schaumblock

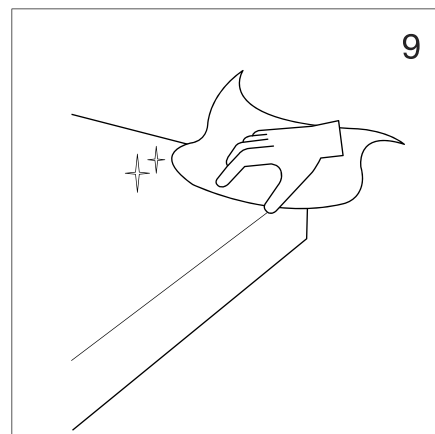
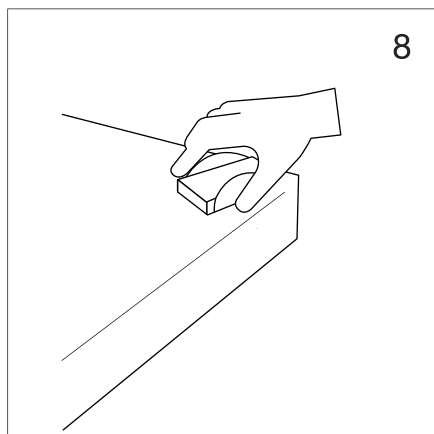
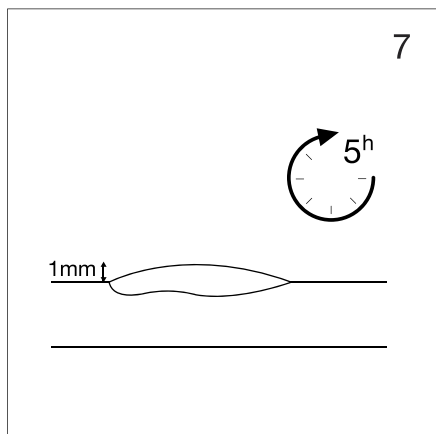
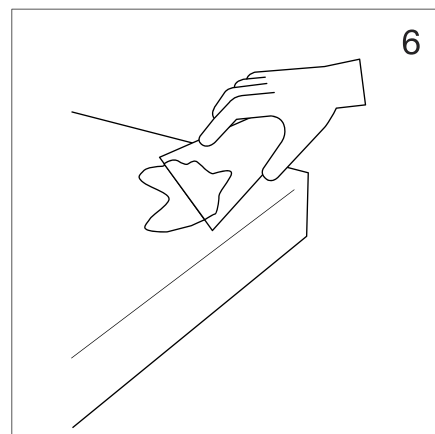
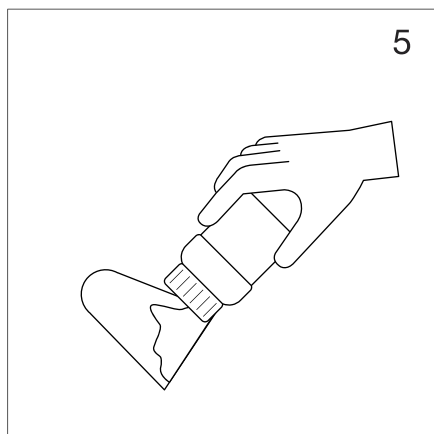
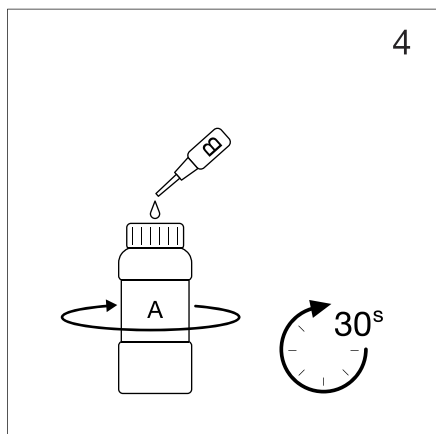
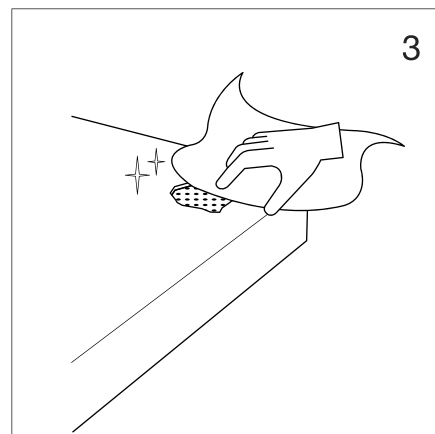
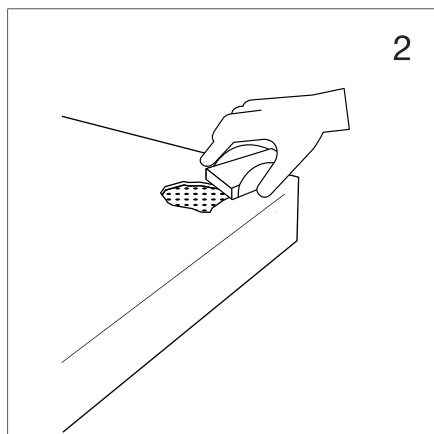
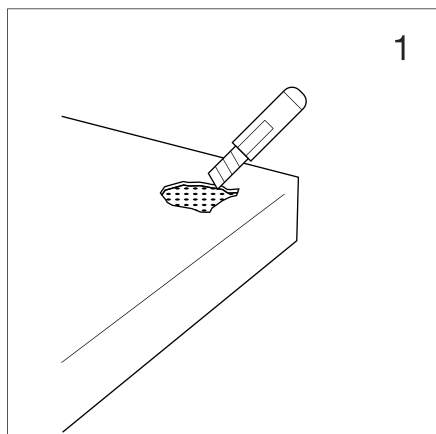

EN: Clean the surface of the shower tray very well. Scrape the gel-coat on the defect area off with scraper. Use the sandpaper to wrap the foamed block around, then sand the defect area. Clean the surface with a dry lint-free cloth, then apply for acetone or ethyl alcohol in water with the lint-free cloth. Surface must be totally clean and dry.

Confect the repair gel-coat and curing agent by the following proportion (gel-coat : curing agent = 25 : 1). Take some repair gel-coat with the scraping plate to fix the broken position flat.

Notes:

1. Don't take too much repair gel-coat on the scraping plate.
2. Remember to fix the defect area flat. When fixing the edge position, avoiding the repair gel-coat flow to the side.
3. Use the scraping plate to scrape the excess repair gel-coat.

Finally let it dry for 5 hours. Again sand the area with sandpaper, retain the surface of its texture. Then clean the surface with a dry lint-free cloth, then apply for acetone or ethyl alcohol in water with the lint-free cloth.

IT: Pulire esaustivamente la zona da dipingere. Raschiare il gel-coat sull'area difettosa con un raschietto. Usare la carta vetrata per avvolgere il blocco di schiuma, poi carteggiare l'area difettosa. Pulire la superficie con un panno asciutto privo di lanugine, si può applicare anche acetone o alcol etilico diluito con acqua con un panno che non perda garze. La superficie deve essere completamente pulita e asciutta.

Confezionare il gel-coat di riparazione e l'agente di stagionatura nella seguente proporzione (gel-coat: agente di stagionatura = 25: 1). Prendere un po' di gel-coat di riparazione con la piastra raschiante per riparare la posizione rotta in piano.

Note:

1. Non mettere troppo gel-coat di riparazione sulla piastra raschiante.
2. Ricordarsi di riparare l'area difettosa in piano. Per riparare la posizione del bordo, evitare che il flusso di gel-coat di riparazione vada verso i lati.
3. Usare la piastra raschiante per raschiare il gel-coat eccessivo di riparazione.

Per finire si deve lasciare asciugare 5 ore. Carteggiare nuovamente l'area con carta vetrata, mantenere la superficie della sua struttura. Poi pulire la superficie con un panno asciutto privo di lanugine, si può applicare anche acetone o alcol etilico diluito con acqua con un panno che non perda garze.

FR: Bien nettoyer la zone à peindre. À l'aide d'un grattoir, vous pouvez enlever le gel-coat sur la zone du défaut. En utilisant le papier de verre, vous pouvez envelopper le bloc de mousse, puis poncer la zone du défaut. Nettoyez la surface avec un chiffon sec non pelucheux et puis appliquez pour l'acétone ou alcool éthylique diluée dans de l'eau avec un tissu qui ne laisse aucun type de duvet. La surface doit être totalement propre et sèche.

Mêlez le gelcoat de réparation et le durcisseur dans la proportion suivante (gelcoat : durcisseur = 25 : 1). Prenez un peu de gélifiant de réparation avec la plaque de grattage pour réparer la position cassée afin qu'il soit plat.

Remarques :

1. Il ne faut pas prendre trop de gélifiant de réparation sur la plaque de grattage.
2. Il ne faut pas oublier de fixer la zone du défaut à plat. Au moment de fixer la position du bord, il faut éviter que le gélifiant de réparation coule le long du côté. Il faut utiliser la plaque à gratter pour racler l'excès de gélifiant de réparation.

Finalemt laisser sécher 5 heures. Il faut à nouveau poncer la zone avec du papier de verre, pour conserver la surface de sa texture. Puis nettoyez la surface avec un chiffon sec non pelucheux, puis appliquez pour l'acétone ou alcool éthylique diluée dans de l'eau avec un tissu qui ne laisse aucun type de duvet.

DE: Reinigen Sie die Oberfläche der Duschwanne gut. Kratzen Sie das Gelcoat auf dem defekten Bereich mit einem Spatel ab. Wickeln Sie den Schaumblock mit dem Schleifpapier um und schleifen Sie dann den defekten Bereich ab. Reinigen Sie die Oberfläche mit einem trockenen, fussselfreien Tuch. Tragen Sie dann Aceton oder Ethylalkohol mit dem fussselfreien Tuch in Wasser auf. Die Oberfläche muss vollkommen sauber und trocken sein.

Bereiten Sie Gelcoat und Härter in den folgenden Anteilen vor (Gelcoat: Härter = 25: 1). Nehmen Sie etwas Gelcoat mit der Schaberplatte, um die beschädigte Position flach zu fixieren.

Hinweise:

1. Nehmen Sie nicht zu viel Gelcoat auf die Schaberplatte.
2. Denken Sie daran, den defekten Bereich flach zu fixieren. Beim Fixieren der Kantenposition ist ein seitliches Fließen des Gelcoats zu vermeiden.
3. Verwenden Sie die Schaberplatte, um das überschüssige Gelcoat abzukratzen.

Lassen Sie es schließlich 5 Stunden trocknen. Schleifen Sie den Bereich erneut mit Sandpapier ab, wobei die Oberfläche seiner Textur erhalten bleiben soll. Reinigen Sie die Oberfläche mit einem trockenen, fussselfreien Tuch. Tragen Sie dann Tuch Aceton oder Ethylalkohol mit dem fussselfreien in Wasser auf.

PRODUCT PACKAGE

EMBALLAGE DE PRODUIT · PACCHETTO DEL PRODOTTO · VERPACKUNG DES PRODUKTES



Step 1

Étape 1
Passo 1
Schritt 1

Strict inspection by QC dept., then clean and deliver to packaging dept. for packing.

Inspection stricte par le service de contrôle de qualité, puis nettoyage et livraison au service d'emballage pour le colisage.

Viene effettuato il controllo rigoroso da parte del reparto di controllo di qualità, poi pulire e consegnare al reparto di imballaggio per l'imballaggio.

Strenge Inspektion durch die Qualitätskontrollabteilung. Reinigen und liefern Sie dann die Verpackungsabteilung zum Verpacken.



Step 2

Étape 2
Passo 2
Schritt 2

With PP bag to protect first, then EPE surround the tray. The COVER will be packed in a small cardboard, then be taped on the drainer part. Or will be packed with the drainer separately.

Tout d'abord, utilisez un sac en PP pour protéger, ensuite avec un EPE pour entourer le plateau. Le grille sera emballé dans un petit carton, puis collé sur la partie égouttoir. Ou bien il sera emballée avec l'égouttoir séparément.

Con la borsa in PP per proteggere prima, poi circolare il piatto con EPE. Il griglia sarà imballato in un piccolo cartone, poi la parte di piletta sarà nastrata o sarà imballata con lo piletta separatamente.

Zuerst mit PP-Tasche zum Schutz verpackt. EPE umgibt dann die Duschwannen. Die Gitter wird in einem kleinen Karton verpackt und dann mit Klebeband am Ablauf befestigt. Oder es wird separat mit dem Ablauf verpackt.



Step 3

Étape 3
Passo 3
Schritt 3

Pack into normal carton and seal with adhesive tape. DAYA also packs according to clients' requirements.

Emballer dans un carton normal et fermez avec du ruban adhésif. DAYA effectue également l'emballage selon les besoins des clients.

Imballare in un cartone normale e sigillare con un nastro adesivo. DAYA può imballare anche secondo le richieste dei clienti.

In normalen Karton verpacken und mit Klebeband verschließen. Produkte von DAYA können auch nach Kundenwunsch verpackt werden.

EXPRESS PACKAGE

COLIS EXPRESS · PACCHETTO ESPRESSO · EXPRESS-VERPACKUNG

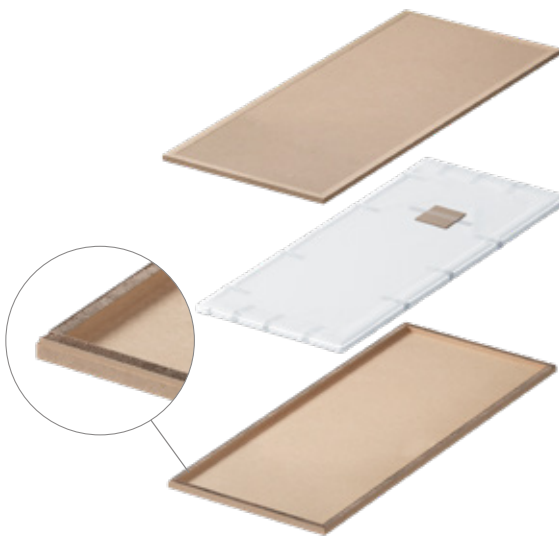

Step 1

Étape 1
Passo 1
Schritt 1

With PP bag to protect first, then EPE surround the tray. The COVER will be packed in a small carboard, then be taped on the drainer part. Or will be packed with the drainer separately.

Tout d'abord, utilisez un sac en PP pour protéger, ensuite avec un EPE pour entourer le plateau. Le grille sera emballé dans un petit carton, puis collé sur la partie égouttoir. Ou bien il sera emballée avec l'égouttoir séparément.

Con la borsa in PP per proteggere prima, poi circondare il piatto con EPE. Il griglia sarà imballato in un piccolo cartone, poi la parte di piletta sarà nastrata o sarà imballata con lo piletta separatamente.

Zuerst mit PP-Tasche zum Schutz verpackt. EPE umgibt dann die Duschwanne. Die Gitter wird in einem kleinen Karton verpackt und dann mit Klebeband am Ablauf befestigt. Oder es wird separat mit dem Ablauf verpackt.

Step 2

Étape 2
Passo 2
Schritt 2

Put the shower tray into the honeycomb carton and seal with adhesive tape.

Le receveur de douche doit être placé dans le carton alvéolé et scellé avec du ruban adhésif.

Posizionare il piatto doccia nel cartone a nido d'ape e sigillare con nastro adesivo.

Duschwanne in den Wabenkarton legen und mit Klebeband verschließen.



Pallet package

Emballage Palette
Pacchetto Con Pallet
Paletten-Verpackung

Normal carton packing with plywood pallet (no fumigation required) and PP strap to fix the shower trays on the pallet, finally, using wrapping film outside to ensure the shower trays fixed well on the pallet.

Emballage normal en carton avec palette en contreplaqué (pas de fumigation nécessaire) et courroie en PP pour fixer les bacs à douche sur la palette, enfin, utilisation d'un film d'emballage à l'extérieur pour garantir une bonne fixation des receveurs de douche à la palette.

Imballaggio normale in cartone con pallet in compensato (senza richiesta di fumigazione) e striscia in PP per fissare i piatti doccia sul pallet, alla fine usare la pellicola di avvolgimento all'esterno per garantire che i piatti doccia siano ben fissati sul pallet.

Normale Kartonverpackung mit Sperrholzpalette (keine Begasung erforderlich) und PP-Band zur Befestigung der Duschwannen auf der Palette. Schließlich die Verwendung von Wickelfolie im Außenbereich, um eine gute Fixierung der Duschwannen auf der Palette zu gewährleisten.

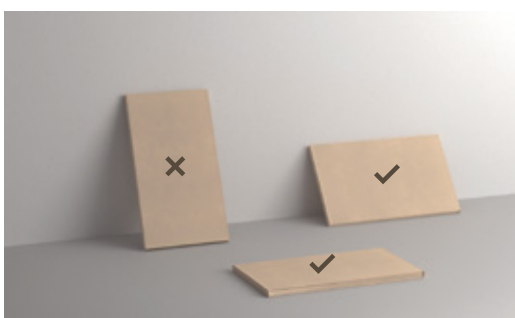

Storage

STOCKAGE
CONSERVAZIONE
LAGER

Always store the shower tray in a horizontal position.

Toujours stocker le receveur en horizontale.

Conservare sempre il piatto orizzontalmente.

Die Duschwanne immer waagrecht lagern.

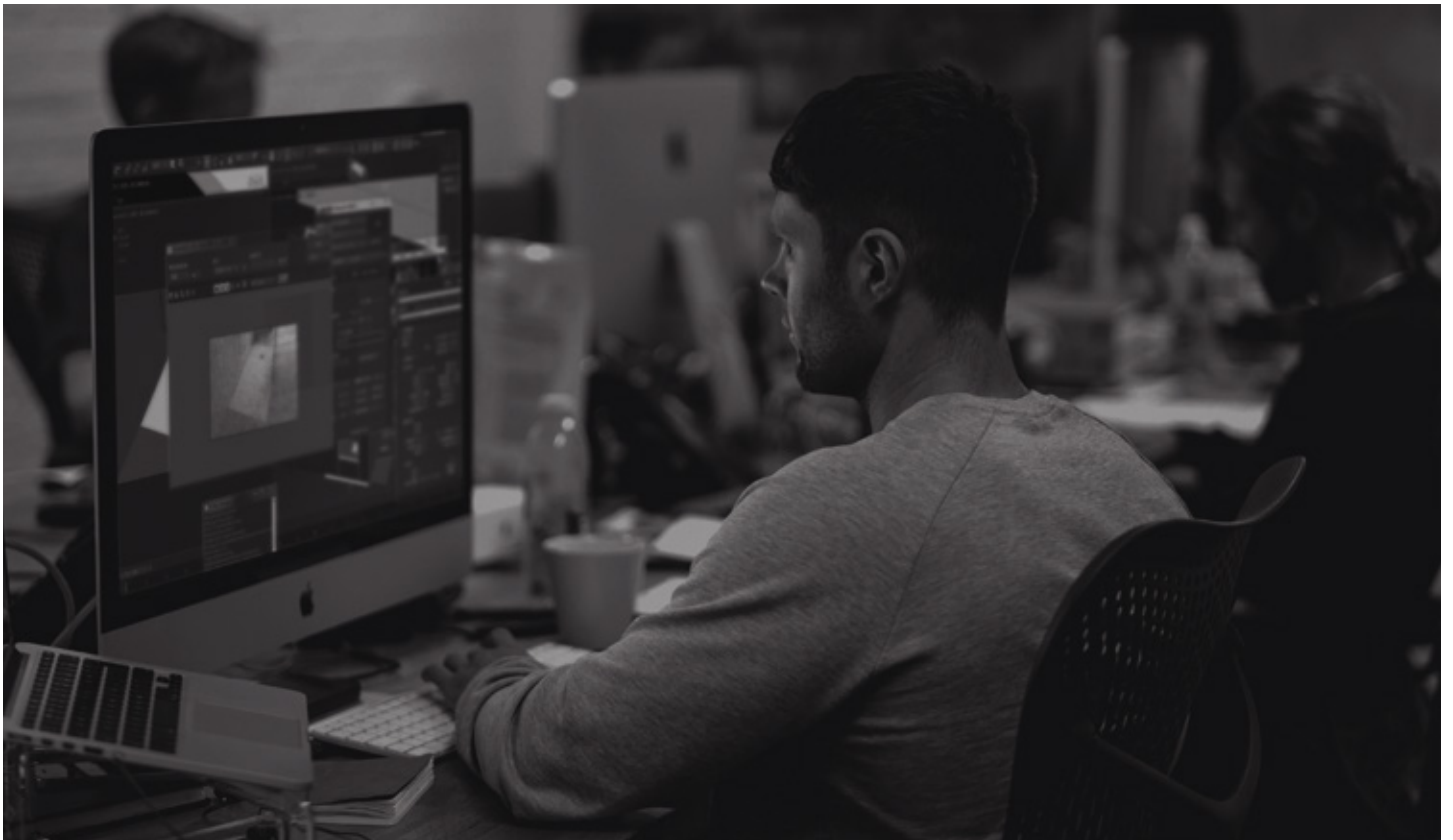

OUR BRANDING SERVICE

NOTRE SERVICE DE MARQUE · IL NOSTRO SERVIZIO DEL MARCHIO · MARKENSERVICE

 We can do custom-made packaging according to customer's requirement.

 Lasering Logo by advanced laser machine to promote customers' brand popularity.

 DAYA provides existing templates of installation manual for customers to choose from.

 DAYA provides 3D video of the process of installing shower tray for customers.

 DAYA provides 3D video of the process of repairing shower tray for customers.

 DAYA provides a wide selection of product's pictures for customers for publicity.

 Possiamo fare imballaggi personalizzati secondo le esigenze del cliente.

 Scrivere il logo in laser con la macchina laser avanzata per promuovere la popolarità del marchio dei clienti.

 DAYA fornisce i modelli esistenti del manuale di installazione tra cui i clienti possono scegliere.

 DAYA fornisce video 3D del processo di installazione del piatto doccia per clienti.

 DATA fornisce video 3D del processo di riparazione del piatto doccia per clienti.

 DAYA fornisce una selezione ampia delle immagini del prodotto per clienti ai fini di pubblicità.

 Nous pouvons réaliser des emballages personnalisés en fonction des besoins du client.

 Le logo laser est réalisé par une machine laser avancée pour promouvoir la popularité de la marque auprès des clients.

 Le logo laser est réalisé par une machine laser avancée pour promouvoir la popularité de la marque auprès des clients.

 DAYA offre aux clients des modèles de manuels d'installation existants, dont ils peuvent faire leur choix.

 DAYA offre une vidéo en 3D sur le processus de réparation des receveurs de douche pour les clients.

 DAYA offre aux clients un large choix de photos de produits destinées à la publicité.

 Maßgeschneiderte Verpackungen können nach Kundenwunsch anfertigt werden.

 Das Laser-Logo durch fortschrittliche Lasermaschine fördert die Markenbekanntheit der Kunden.

 DAYA bietet Kunden vorhandene Vorlagen für die Installationsanleitung zur Auswahl.

 DAYA bietet Kunden ein 3D-Video des Installationsverfahrens der Duschwanne.

 DAYA bietet Kunden ein 3D-Video des Reparaturverfahrens der Duschwanne.

 DAYA bietet Kunden eine große Auswahl an Produktbildern für Werbezwecke.

OUR BRANDING SERVICE

NOTRE SERVICE DE MARQUE · IL NOSTRO SERVIZIO DEL MARCHIO · MARKENSERVICE



Printing customer's required information and brand Logo on product's carton and accessories' carton. We can design label for you as well. (Please provide us your Logo file in AI, PSD, PDF, JPG or PNG format.)

Impression des informations requises par le client et du logo de la marque sur le carton du produit et des accessoires. En outre, nous pouvons concevoir une étiquette pour vous. (Veuillez nous fournir votre fichier Logo au format AI, PSD, PDF, JPG ou PNG).

Stampare le informazioni richieste dal cliente e il logo del marchio sul cartone del prodotto e sul cartone degli accessori. Ti possiamo progettare anche etichette. (Basta fornirci il file del tuo logo in formato in AI, PSD, PDF, JPG o PNG per favore.)

Die vom Kunden gewünschten Informationen und das Markenlogo werden auf den Produktkarton und den Zubehörkarton gedruckt. Wir können auch Etiketten für Sie entwerfen. (Bitte geben Sie Ihre Logo-Datei im Format von AI, PSD, PDF, JPG oder PNG.)



We can laser Logo on the cover, helping you to promote brand popularity.

Pour promouvoir la popularité de la marque, nous pouvons apposer le logo au laser sur la couverture.

Possiamo anche fare il logo con laser sul griglia per aiutarti a promuovere la popolarità del marchio.

Das Laser-Logo kann auf dem Gitter gedruckt werden, um Ihre Markenbekanntheit zu fördern.



Editing installation manual according to customer's demand. We'll provide our existing templates of installation manual for you to choose from.

Rédaction du manuel d'installation conformément à la demande du client. Nous vous fournissons nos modèles de manuel d'installation existants pour que vous puissiez choisir.

Modificare il manuale di installazione in base alla richiesta del cliente. Ti forniremo i nostri modelli esistenti del manuale di installazione tra cui scegliere.

Die Installationsanleitung kann nach Kundenwunsch bearbeitet werden. Wir bieten Ihnen vorhandene Vorlagen für die Installationsanleitung zur Auswahl.

OUR BRANDING SERVICE

NOTRE SERVICE DE MARQUE · IL NOSTRO SERVIZIO DEL MARCHIO · MARKENSERVICE



To help our customers to solve the after-sales service problem and bring in consumers, DAYA's professional design team creates the video of shower tray's installation, the video guides the consumer through the installation clearly. You can select the video element you need, the definition can be 480p, 720p, 1080p.

Pour aider nos clients à résoudre le problème du service après-vente et à faire venir des consommateurs, l'équipe de concepteurs professionnels de DAYA crée la vidéo de l'installation du receveur de douche, qui guide clairement le consommateur tout au long de l'installation. Vous pouvez choisir l'élément vidéo dont vous avez besoin, la définition peut être de 480p, 720p, 1080p.

Per aiutare i nostri clienti a risolvere il problema del servizio post-vendita e attrarre i consumatori, il team di progettazione professionale di DAYA crea il video dell'installazione del piatto doccia che conduce i consumatori al termine dell'installazione in modo chiaro. Puoi selezionare l'elemento di video necessario, la definizione può essere 480p, 720p, 1080p.

Um unseren Kunden bei der Lösung von Kundendienstproblemen zu helfen und Verbraucher anzulocken, hat das professionelle Designteam von DAYA ein Video zur Installation der Duschwanne erstellt. Das Video führt den Verbraucher anschaulich durch die Installation. Sie können die gewünschte Videoauflösung (480p, 720p, 1080p) auswählen.

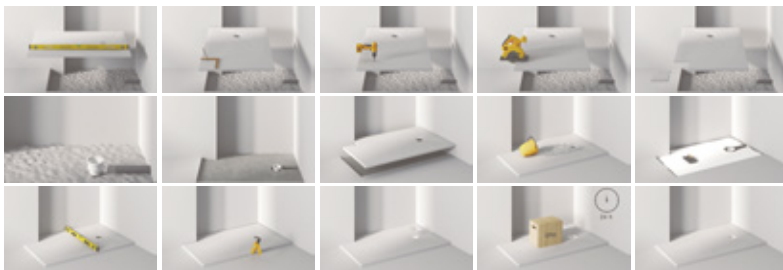

To help our customers to solve the after-sales service problem and bring in consumers, DAYA's professional design team creates the video of shower tray's repair, the video guides the consumer easy to repair the shower tray. You can select the video element you need, the definition can be 480p, 720p, 1080p.

Pour aider nos clients à résoudre le problème du service après-vente et faire venir les consommateurs, l'équipe de conception professionnelle de DAYA crée la vidéo de la réparation du receveur de douche. La vidéo guide le consommateur dans la réparation facile du receveur de douche. Vous pouvez choisir l'élément vidéo dont vous avez besoin, la définition peut être de 480p, 720p, 1080p.

Per aiutare i nostri clienti a risolvere il problema del servizio post-vendita e attrarre i consumatori, il team di progettazione professionale di DAYA crea il video della riparazione del piatto doccia che conduce i consumatori al termine della riparazione in modo chiaro. Puoi selezionare l'elemento di video necessario, la definizione può essere 480p, 720p, 1080p.

Um unseren Kunden bei der Lösung von Kundendienstproblemen zu helfen und Verbraucher anzulocken, hat das professionelle Designteam von DAYA ein Reparaturvideo der Duschwanne erstellt. Das Video führt den Verbraucher leicht zur Reparatur der Duschwanne. Sie können die gewünschte Videoauflösung (480p, 720p, 1080p) auswählen.



OUR BRANDING SERVICE

NOTRE SERVICE DE MARQUE · IL NOSTRO SERVIZIO DEL MARCHIO · MARKENSERVICE

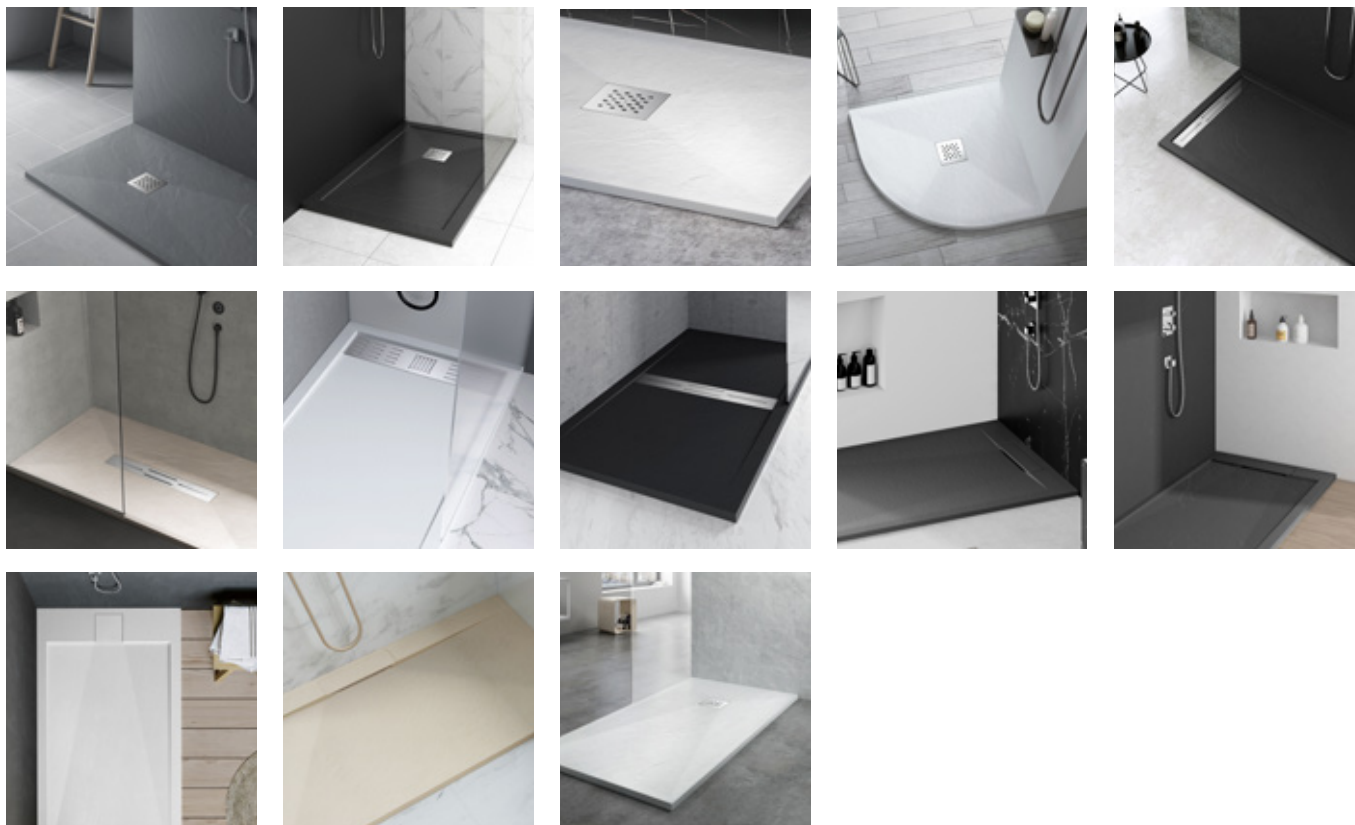

EN: Our creative technical department creates a wide selection of pictures with high-definition. We can provide a set of pictures includes 10 product images and 10 scene graphs to our customers for advertisement promotion, helping to complete and perfect your catalogs and company website.

IT: Il nostro ufficio tecnico creativo ha creato un'ampia selezione di immagini ad alta definizione. Possiamo fornire un set di immagini che include 10 immagini di prodotto e 10 grafici di scena ai nostri clienti per la promozione pubblicitaria, in modo da aiutarli a completare e perfezionare i loro cataloghi e il sito web aziendale.

FR: Notre département technique de créativité crée une large sélection d'images en haute définition. Nous pouvons ainsi offrir à nos clients un ensemble de photos comprenant 10 images de produits et 10 graphiques de scènes pour la promotion de publicités, permettant ainsi de compléter et de perfectionner vos catalogues et le site web de votre entreprise.

DE: Unsere kreative technische Abteilung erstellt eine große Auswahl an Produktbildern mit hoher Auflösung. Wir können unseren Kunden eine Sammlung von Bildern, einschließlich 10 Produktbildern und 10 Szenebildern, für Werbezwecke zur Verfügung stellen, um Ihre Kataloge und Ihre Firmenwebsite zu vervollständigen und zu verbessern.

Technical specifications

ICON	CHARACTERISTIC OR ATTRIBUTE	DATA	OBSERVATIONS
	Ultra-thin	2.5cm	Facilitates access to the shower area and improves the aesthetic.
	Anti-slip	Class 3	Anti-slip level according to Standard UNE 41901:2017.
	Mass coloration	✓	Facilitates the repair and minimises the appearance of small surface flaws.
	Ecological material	✓	Composite material. 90% of the components are resin and mineral fillers.
	Antibacteria	✓	Made antibacterial by the Gelcoat.
	Waterproof	<0.01%	The absorption of the shower trays less than 0.01%.
	Resistance to UV discolouration	✓	Colour and intensity that will last over time.
	Cleaning	✓	Easy to clean.
	Resistance to wear and tear	✓	Highly durable material, barcol hardness 57.
	Gelcoat	1mm	Extremely hard surface. Hot-melt mould coating. Not painted.
	Dimensional tolerance threshold	✓	Our material offers great dimensional stability.
	Cutable	✓	Able to be adapted to the available space.
	Custom-made	✓	Supports customization according to client's needs.
	Optional colours	✓	Possibility of manufacturing with the optional color in catalogue.
	Quality guarantee	5 years	5 years guarantee.
	Laser Logo	✓	Lasering Logo by advanced laser machine.
	Repair kit. Supports repairs	✓	Repair kit will be provided for the repair of small bumps and imperfection.
	Weight without package	✓	Approx. 32.93kg/m ²
	Weight with package	✓	Approx. 34.4kg/m ²
	Include drainers	✓	DAYA's shower trays include drainers.
	Include covers	✓	DAYA's shower trays include covers.
	Drainer certificate	✓	Certificated by EN 274-1:2002.
	Cover material	✓	Covers are produced by 304 stainless steel.
	Accordant cover	✓	Optional cover is supplied in the same colour as the shower tray.
	Pallet	plywood	Packed with plywood pallet (no fumigation required).

Spécifications techniques

ICÔNE	CARACTÉRISTIQUE OU PROPRIÉTÉ	DONNÉE	OBSERVATIONS
	Extra-plat	2.5cm	Facilite l'accès à la zone de douche et offre un résultat plus esthétique.
	Antidérapante	Clase 3	Niveau d'anti-dérapant conforme à la Norme UNE 41901:2017.
	Couleur dans la masse	✓	Facilite la réparation et rend les petites imperfections superficielles moins visibles.
	Matériau écologique	✓	Matériau composite. 90% des composants sont du quartz et des charges minérales.
	Antibactérien	✓	Antibactérien grâce à l'action du Gel Coat.
	Imperméable	<0.01%	L'absorption des receveurs de douche est inférieure à 0,01%
	Résistance à la décoloration par UV	✓	Couleur et intensité durables dans le temps.
	Nettoyage	✓	Nettoyage facile
	Résistance à l'usure	✓	Matériau de grande durabilité, dureté barcol 57.
	Gel Coat	1mm	Dureté superficielle importante. Recouvrement thermomoulé. Non peint.
	Seuil de tolérance dimensionnelle	✓	Notre matériau offre une grande stabilité dimensionnelle.
	Découpe	✓	Peut être adapté à l'espace disponible.
	Personnalisable	✓	Favorise la personnalisation conformément aux besoins du client.
	Couleurs en option	✓	Possibilité de fabrication dans la couleur optionnelle dans le catalogue.
	Garantie de qualité	5 ans	5 ans de garantie.
	Logo de laser	✓	Logo de laser par machine laser avancée.
	Kit de réparation. Réparable	✓	Ce matériel permet de réparer les petits chocs et les imperfections.
	Poids sans emballage	✓	Environ 32.93 kg/m ²
	Poids avec emballage	✓	Environ 34.4 kg/m ²
	Bonde incluse	✓	Les receveurs de douche de DAYA sont équipés d'égouttoirs.
	Grille incluse	✓	Les receveurs de douche DAYA sont équipés de couvertures.
	Certification de bonde d'évacuation	✓	Certifié par EN 274-1:2002.
	Matériel de couverture	✓	Les couvertures sont fabriquées en acier inoxydable 304.
	Couverture accordée	✓	La grille en option est livrée dans la même couleur que le receveur.
	Palette	Contreplaqué	Empaqueté avec une palette en contreplaqué (pas de fumigation nécessaire).

Technical specifications

ICON	CHARACTERISTIC OR ATTRIBUTE	DATA	OBSERVATIONS
	Ultra-sottile	2.5cm	Facilita l'accesso alla zona di doccia e migliora l'estetica.
	Antiscivolo	Classe 3	Livello antiscivolo secondo lo standard UNE 41901:2017.
	Impasto colorato	✓	Facilita la riparazione e minimizza l'aspetto di piccoli difetti superficiali.
	Materiale ecologico	✓	Materiale composito. Il 90% dei componenti è resine e cariche minerali.
	Antibatteri	✓	Fatto antibatterico dal Gelcoat.
	Impermeabile	<0.01%	L'assorbimento dei piatti doccia è inferiore allo 0,01%.
	Resistente ai raggi UV	✓	Colore e intensità che dureranno più lungo nel tempo.
	Pulizia	✓	Facile da pulire.
	Resistenza all'usura	✓	Materiale altamente durevole, durezza barcol 57.
	Gelcoat	1mm	Superficie estremamente dura. Rivestimento di stampo termofusibile. Non verniciato.
	Soglia di tolleranza dimensionale	✓	Il nostro materiale offre una grande stabilità dimensionale.
	Tagliabile	✓	Capace di adattarsi allo spazio disponibile.
	Personalizzabile	✓	Supporta la personalizzazione secondo le esigenze dei clienti.
	Colori opzionali	✓	Possibilità di produzione con il colore opzionale in catalogo.
	Garanzia di qualità	5 anni	Garanzia di 5 anni.
	Logo di Laser	✓	Scrittura del Logo in laser con la macchina laser avanzata.
	Kit di riparazione. Riparabile	✓	È fornito un kit di riparazione per riparare piccoli urti e imperfezioni.
	Peso senza imballaggio	✓	Circa 32.93kg/m ²
	Peso con imballaggio	✓	Circa 34.4kg/m ²
	Include scolapiatti	✓	Il piatto doccia di DAYA include scolapiatti.
	Include coperchi	✓	Il piatto doccia di DAYA include coperchi.
	Certificato di scolapiatti	✓	Certificato da EN 274-1:2002.
	Materiale di coperchio	✓	I coperchi sono fatti di acciaio inossidabile 304.
	ccorrispondente	✓	Il griglia opzionale è fornito nello stesso colore come il piatto doccia.
	Pallet	Compensato	Imballato con pallet di compensato (senza richiesta di fumigazione).

Technical specification

SYMBOL	EIGENSCHAFT ODER ATTRIBUT	DATEN	BEMERKUNGEN
	Ultra dünn	2.5cm	Erleichtert den Zugang zum Duschbereich und verbessert die Ästhetik.
	Rutschfest	Klasse 3	Rutschfestigkeit gemäß Norm UNE 41901:2017.
	In der Masse eingefärbt	✓	Erleichtert die Reparatur und minimiert das Auftreten von kleinen Oberflächenfehlern.
	Ökologisches Material	✓	Verbundwerkstoff. 90% der Komponenten sind Harz und mineralische Füllstoffe.
	Antibakteriell	✓	Antibakteriell durch das Gelcoat
	Wasserdicht	<0.01%	Die Absorptionsrate der Duschwanne beträgt weniger als 0,01%.
	Beständigkeit gegen UV-Verfärbung	✓	Farbe und Intensität halten im Laufe der Zeit an.
	Reinigung	✓	Einfach zu reinigen
	Beständigkeit gegen Verschleiß	✓	Hoch beständiges Material, Barcol-Härte 57.
	Gelcoat	1mm	Extrem harte Oberfläche. Heißschmelzform-Beschichtung. Nicht lackiert.
	Dimensionale Toleranzschwelle	✓	Unser Material bietet eine große Formbeständigkeit.
	Schneidbar	✓	Kann an den verfügbaren Raum angepasst werden.
	Maßgeschneidert	✓	Unterstützt die Anpassung an die Bedürfnisse des Kunden.
	Optionale Farben	✓	Möglichkeit der Herstellung mit der optionalen Farbe im Katalog.
	Qualitätsgarantie	5 Jahre	5 Jahre Garantie.
	Laser-Logo	✓	Das Laser-Logo wurde von der fortschrittlichen Lasermaschine gedruckt.
	Reparatursatz. Unterstützt Reparaturen	✓	Ein Reparatursatz wird bereitgestellt, um kleine Unebenheiten und Defekte zu reparieren.
	Gewicht ohne Verpackung	✓	ca. 32.93kg/m ²
	Gewicht mit Verpackung	✓	ca. 34.4kg/m ²
	Inkl. Abläufe	✓	Duschwannen von DAYA enthalten Abläufe.
	Inkl. Gitter	✓	Duschwannen von DAYA enthalten Gitter.
	Qualitätszertifikat des Ablauf	✓	Zertifiziert nach EN 274-1:2002.
	Material der Gitter	✓	Gitter werden aus Edelstahl 304 hergestellt.
	Übereinstimmende Gitter	✓	Die optionale Gitter wird in der gleichen Farbe wie die Duschwanne geliefert.
	Palette	Sperrholz	Verpackt mit Sperrholzpalette (keine Begasung erforderlich).

FAQ

What is the origin of your products?

We have two factories in China. One in Shantou City, Guangdong Province, another one in Huaian City, Jiangsu Province. Both of our two factories produce shower tray and wash basin. You can make your choice.

Are you manufacturer or trade company?

We are the manufacturer specializes in manufacturing shower trays and wash basins for 21 years. Also we have large warehouse and quality control department.

What is your sample policy?

We can freely supply the sample if we have goods in stock, but the customers have to pay for the freight charge.

How long is the sample time of the shower tray?

Proofing is usually 5-7 working days.

Can I have our own OEM?

We have our professional technical team, we can design and produce products according to your ideas and requirements. We can build the molds and fixtures.

How about your delivery time?

Generally, it will take 30 days upon receipt of your payment. The specific delivery time depends on the item and the quantity of your order.

What is your payment term?

EXW or FOB.

Do you have an Minimum Order Quantity requirement?

Usually our MOQ requirement is a 20'GP container.

What quality certificates can you provide?

We can provide CE certificate and ISO9001 for our shower trays.

Can we have our Logo or company name to be printed on your products or package?

Sure. We could laser your Logo on your products by advanced laser machine. We could print your Logo and information you require on the package. We can stick labels on the package as well.

Will you provide repair kit to repair the product?

Our shower trays are repairable, we could provide repair kits for customers for repairing the goods by themselves.

What extra service will you provide?

Our creative Technical Department follows product's image rendering and producing video, thereby cooperates with customers' brand promotion.

Which countries are your products mainly sold to?

With unremitting efforts in the past 21 years, we have attracted customers from 26 countries. Such as Italy, France, UK, Austria, Netherlands and so on.

How do you ensure product quality?

You deserve the highest-quality product and packing services every single time. This is why our quality system extends throughout the whole production process until the final delivery. We have strict quality testing department and our own professional quality inspector to carefully follow up on all details.

What happens if the product is damaged when I receive the goods?

If the damage is caused by our side before container loading, we will shoulder the responsibility and compensate for this product. If the damage is caused by transportation, and our term is usually FOB, you will need to claim this to your insurance company or shipping company.

How will you deal with the product break in your promised warranty?

Please send us photos of the broken product so we can know the problem and give you a appropriate solution, we can also prepare repair kit. If the problem cannot be solved after, we will compensate for this product.

Why should we choose your company over others?

After 21 years of development, DAYA is able to fulfill the professional capability of techniques research and production, and seek for greater perfection in every production step. Our professional technical team engage in designing and producing products to satisfy customer need and the market demand. "Quality First, Trustworthiness Cooperation, Mutual Benefit" is the general idea of DAYA, we hope to enter into business with you in the future.

Can you share your customers' names?

I am afraid we are not able to disclose their names because they require privacy. We owe a duty of care to our clients to prevent any risk of harm. If we can work together, we will also keep all of your information safe. Thanks for your understanding.

QUESTIONS FRÉQUENTES

Quelle est l'origine de vos produits ?

Nous possédons deux usines en Chine. L'une dans la ville de Shantou, province de Guangdong, l'autre dans la ville de Huaian, province de Jiangsu. Nos deux usines produisent des receveurs de douche et des lavabos. Vous pouvez faire votre choix.

Etes-vous un fabricant ou une entreprise commerciale ?

Nous sommes le fabricant spécialisé dans la fabrication de receveurs de douche et de lavabos depuis 21 ans. Par ailleurs, nous possédons un grand entrepôt et un service de contrôle de la qualité.

Quel est votre exemple de politique ?

Un échantillon peut être livré librement si nous avons des marchandises en stock, mais les frais de transport sont à la charge du client.

Quelle est la durée de l'échantillonnage du receveur de douche ?

Le contrôle est généralement réalisé dans un délai de 5 à 7 jours ouvrables.

Est-ce que je peux avoir notre propre OEM ?

Nous disposons de notre équipe technique professionnelle, nous pouvons concevoir et fabriquer des produits conformément à vos idées et à vos attentes. De plus, nous pouvons construire les moules et les accessoires.

Quel est votre délai de livraison ?

Généralement, il est de 30 jours à compter de la réception de votre paiement. Le temps spécifique de livraison varie avec chaque article et la quantité de votre commande.

Quel est votre moyen de paiement ?

EXW ou FOB.

Exigez-vous une quantité minimale de commande ?

Généralement, nous exigeons un conteneur de 20' GP.

Quels certificats de qualité pouvez-vous offrir ?

Nous pouvons offrir le certificat CE et ISO9001 pour nos receveurs de douche.

Pouvons-nous faire imprimer notre logo ou le nom de notre entreprise sur vos produits ou emballages ?

Bien sûr, il est possible d'imprimer votre logo au laser sur vos produits grâce à une machine laser de pointe. Nous pouvons également imprimer votre logo et les informations dont vous avez besoin sur l'emballage. De même, nous pouvons coller des étiquettes sur l'emballage.

Fournissez-vous un kit de réparation pour réparer le produit ?

Nos receveurs de douche sont réparables, nous pourrions également fournir des kits de réparation aux clients pour qu'ils puissent réparer eux-mêmes les produits.

Quel service supplémentaire allez-vous fournir ?

Notre Département Technique créatif assure le suivi du rendu de l'image du produit et la production de la vidéo, coopérant ainsi à la promotion de la marque des clients.

Pour quels pays vos produits sont-ils principalement vendus ?

Grâce à des efforts inlassables au cours des 21 dernières années, notre société a attiré des clients de 26 pays. Tels que l'Italie, la France, le Royaume-Uni, l'Autriche, les Pays-Bas, etc.

Comment garanzissez-vous la qualité des produits ?

Vous bénéficiez à chaque fois de produits et de services d'emballage de la plus haute qualité. C'est pourquoi notre système de qualité s'étend à l'ensemble du processus de production jusqu'à la livraison finale. Nous possédons un service de contrôle de la qualité très rigoureux et notre propre inspecteur professionnel de la qualité se charge de suivre soigneusement tous les détails.

Que se passe-t-il si le produit est endommagé lorsque je reçois la marchandise ?

Si la détérioration est provoquée par notre propre faute avant le chargement du conteneur, nous en porterons la responsabilité et indemniserons ce produit. En revanche, si la détérioration est engendrée par le transport, et que notre terme est généralement FOB, vous devrez en faire la demande auprès de votre compagnie d'assurance ou de transport.

Que ferez-vous en cas de rupture du produit dans la garantie promise ?

Merci de nous envoyer des photos du produit cassé afin que nous puissions connaître le problème et vous donner une solution appropriée, et nous pouvons aussi préparer un kit de réparation. En cas d'impossibilité de résoudre le problème plus tard, nous vous rembourserons ce produit.

Pourquoi devrions-nous choisir votre entreprise plutôt que d'autres ?

Après 21 ans de développement, DAYA est capable de remplir la capacité professionnelle de recherche et de production de techniques, et de rechercher une meilleure performance à chaque étape de la production. Notre équipe technique professionnelle se consacre à la conception et à la production de produits destinés à satisfaire les besoins des clients et la demande du marché. "Qualité d'abord, Coopération de fiabilité, Avantage mutuel" est l'idée générale de DAYA, nous souhaitons entrer en affaires avec vous au futur.

Pouvez-vous partager les noms de vos clients ?

Je crains que nous ne puissions pas divulguer leur nom car ils ont besoin d'une certaine confidentialité. Nous devons faire preuve de prudence envers nos clients pour empêcher tout risque de préjudice. Si nous parvenons à travailler ensemble, nous assurerons aussi la sécurité de toutes vos informations. Merci de votre compréhension.

Domande frequenti

Qual è l'origine dei tuoi prodotti?

Abbiamo due fabbriche in Cina: una nella città di Shantou, nella provincia del Guangdong, l'altra nella città di Huaian, nella provincia di Jiangsu. Entrambe le nostre fabbriche producono piatto doccia e lavabo. Puoi fare la tua scelta.

Siete un produttore o un'impresa commerciale?

Siamo un produttore specializzato nella produzione di piatti doccia e lavabi da 21 anni. Abbiamo anche un magazzino grande e un reparto di controllo qualità.

Cosa è la vostra politica di campione?

Possiamo fornire gratis il campione se abbiamo merce in magazzino, ma le spese di spedizione sono a carico dei clienti.

Quanto dura il tempo di campionamento del piatto doccia?

La verifica dura di solito 5-7 giorni lavorativi.

Possiamo avere il nostro OEM?

Abbiamo il nostro team tecnico professionale e siamo in grado di progettare e realizzare prodotti secondo le vostre idee e richieste. Possiamo fare anche stampi e attrezzature.

Quanto tempo serve per la consegna?

Di solito, ci vorranno 30 giorni dal giorno in cui riceviamo il vostro pagamento. Il tempo di consegna specifico dipende dall'articolo e dalla quantità del vostro ordine.

Qual è il vostro termine di pagamento?

EXW o FOB.

Avete un requisito di minima quantità di ordine?

Di solito il nostro requisito MOQ è un contenitore da 20 GP.

Quali certificati di qualità riuscite a fornirci?

Possiamo fornire certificato CE e ISO9001 per i nostri piatti doccia.

Possiamo far stampare il nostro logo o il nome della ditta sui vostri prodotti o sull'imballaggio?

Certo. Potremmo scrivere il vostro logo in laser sui vostri prodotti con una macchina laser avanzata. Potremmo stampare il vostro logo e le informazioni richieste sul pacchetto. Possiamo anche attaccare etichette sul pacchetto.

Ci fornirete un kit di riparazione per riparare il prodotto?

I nostri piatti doccia sono riparabili, potremmo fornire i kit di riparazione per i clienti per riparare le merci da soli.

Che altro servizio avrete?

Il nostro ufficio tecnico creativo segue la resa delle immagini del prodotto e produce il video, quindi collaborando con la promozione del marchio dei clienti.

In quali paesi sono venduti principalmente i vostri prodotti?

Con gli impegni continui negli ultimi 21 anni, abbiamo attratto i clienti provenienti da 26 paesi, per esempio, Italia, Francia, Inghilterra, Australia, Paesi bassi ecc.

Come garantite la qualità del prodotto?

Vi meritate la massima qualità dei prodotti e dei servizi di imballaggio ogni volta. Ecco perché il nostro sistema di qualità coinvolge l'intero processo di produzione fino alla consegna finale. Abbiamo un reparto rigoroso di controllo qualità e il nostro ispettore di qualità professionale per seguire attentamente tutti i dettagli.

Cosa succede se il prodotto è danneggiato alla ricezione della merce?

Se il danno è causato dalla nostra parte prima di caricare il container, ci assumeremo la responsabilità e dovremmo darvi il risarcimento per questo prodotto. Se il danno si è verificato durante il trasporto e il nostro termine è di solito FOB, voi dovrete richiederlo alla compagnia di assicurazione o alla ditta del trasporto.

Come affronterete la rottura del prodotto nella garanzia promessa?

Potete inviarci le foto del prodotto rotto per favore in modo che possiamo capire il problema e darvi una soluzione appropriata, possiamo anche preparare il kit di riparazione. Se il problema non si risolve ancora, provvederemo a compensare questo prodotto.

Perché dovremmo scegliere la vostra ditta invece di altre?

Dopo 21 anni di sviluppo, DAYA è in grado di soddisfare la capacità professionale di ricerca e produzione delle tecniche, cerca di perfezionare il prodotto in ogni fase della produzione. Il nostro team tecnico professionale si occupa di progettare e produrre prodotti per soddisfare le esigenze dei clienti e la domanda del mercato. "La qualità nel primo posto, cooperazione in fiducia, beneficio reciproco" è l'idea generale di DAYA, speriamo di collaborare con voi in futuro.

Potete condividere i nomi dei clienti?

Temo che non siamo in grado di rivelare i loro nomi in base alla loro privacy. Abbiamo l'obbligo di diligenza nei confronti dei nostri clienti per prevenire eventuali rischi di danno. Se possiamo lavorare insieme, terremo anche tutte le vostre informazioni in modo sicuro. Grazie per la vostra comprensione.

FAQ

Woher stammt Ihr Produkt?

Wir haben zwei Fabriken in China. Eine in der Stadt Shantou in der Provinz Guangdong und die andere in der Stadt Huai'an in der Provinz Jiangsu. Beide Fabriken stellen Duschwannen und Waschbecken her. Sie können Ihre Wahl treffen.

Sind Sie Hersteller oder Handelsunternehmen?

Wir sind der Hersteller, der sich seit 21 Jahren auf die Herstellung von Duschwannen und Waschbecken spezialisiert hat.

Was ist die Musterpolitik?

Wir können das Muster frei liefern, wenn die Waren auf Lager vorhanden sind. Aber die Kunden müssen die Frachtkosten bezahlen.

Wie lang ist die Probezeit der Duschwanne?

Es dauert in der Regel 5-7 Arbeitstage.

Haben Sie einen eigenen OEM?

Wir haben unser professionelles technisches Team. Wir können Produkte nach Ihren Ideen und Anforderungen entwerfen und herstellen. Wir können die Formen und Vorrichtungen bauen.

Wie lang ist die Lieferzeit?

In der Regel dauert es 30 Tage nach Eingang Ihrer Zahlung. Die spezifische Lieferzeit hängt vom Artikel und von der Menge Ihrer Bestellung ab.

Wie lautet die Handelsbedingung?

EXW oder FOB.

Haben Sie eine Mindestbestellmenge?

Normalerweise ist die Mindestbestellmenge ein 20GP-Container.

Welche Qualitätszertifikate können Sie vorlegen?

Wir können CE-Zertifikat und ISO9001 für unsere Duschwannen anbieten.

Können wir unser Logo oder unseren Firmennamen auf Ihre Produkte oder Verpackungen drucken lassen?

Natürlich. Wir können Ihr Logo auf Ihren Produkten mit einer fortschrittlichen Lasermaschine drucken. Wir können Ihr Logo und die von Ihnen gewünschten Informationen auf die Verpackung drucken. Wir können auch Etiketten auf die Verpackung kleben.

Werden Sie ein Reparaturset zur Verfügung stellen, um das Produkt zu reparieren?

Unsere Duschwannen sind reparabel. Wir könnten den Kunden ein Reparaturset zur Verfügung stellen, damit sie die Waren selbst reparieren können.

Welche zusätzlichen Dienstleistungen werden Sie anbieten?

Unsere kreative technische Abteilung verfolgt die Bildwiedergabe des Produkts und produziert das Video, um die Markenbekanntheit der Kunden zu fördern.

In welche Länder werden Ihre Produkte hauptsächlich verkauft?

Mit unermüdlichen Anstrengungen in den letzten 20 Jahren haben wir Kunden aus 26 Ländern gewonnen. Zum Beispiel aus Italien, Frankreich, Großbritannien, Österreich, Niederlande, usw.

Wie stellen Sie die Produktqualität sicher?

Sie verdienen jedes Mal Produkte und Verpackungsdienstleistungen von höchster Qualität. Aus diesem Grund erstreckt sich unser Qualitätssystem über den gesamten Produktionsprozess bis hin zur endgültigen Auslieferung. Wir haben eine Abteilung für strenge Qualitätskontrolle und unsere eigenen professionellen Qualitätsprüfer, die alle Details sorgfältig verfolgen.

Was soll ich tun, wenn das Produkt nach Erhalt beschädigt ist?

Wenn der Schaden vor dem Laden des Containers von unserer Seite verursacht wird, übernehmen wir die Verantwortung und entschädigen für dieses Produkt. Wenn der Schaden durch den Transport verursacht, müssen Sie dies bei Ihrer Versicherungsgesellschaft oder Speditionsfirma geltend machen, da unsere Handelsbedingung in der Regel FOB beträgt.

Wie sollte ich während der Garantiezeit mit dem beschädigten Produkt umgehen?

Bitte senden Sie uns Fotos des defekten Produkts, damit wir das Problem erkennen und Ihnen eine geeignete Lösung anbieten können. Wir können auch Reparatursätze bereitstellen. Wenn das Problem danach nicht gelöst werden kann, werden wir für dieses Produkt entschädigen.

Warum sollte ich Ihr Unternehmen anderen vorziehen?

Nach 21 Jahren der Entwicklung ist DAYA in der Lage, die professionelle Fähigkeit der Forschung und Herstellung zu erfüllen und nach größerer Perfektion in jedem Produktionsschritt zu streben. Unser professionelles technisches Team beschäftigt sich mit dem Entwurf und der Herstellung von Produkten, um die Kundenbedürfnisse und die Marktnachfrage zu befriedigen. „Qualität zuerst, Zusammenarbeit mit Vertrauenswürdigkeit, gegenseitiger Nutzen“ ist die Grundidee von DAYA. Wir hoffen, in Zukunft mit Ihnen ins Geschäft zu kommen.

Können Sie die Namen Ihrer Kunden freigeben?

Ich fürchte, dass wir ihre Namen aus Datenschutzgründen nicht offenlegen können. Wir sind unseren Kunden zur Sorgfalt verpflichtet, um jegliches Schadensrisiko zu vermeiden. Wenn wir zusammenarbeiten können, werden wir auch alle Ihre Informationen sicher aufbewahren. Vielen Dank für Ihr Verständnis.

VR SHOWROOM

SALLE D'EXPOSITION VR · SHOWROOM VR · VR SHOWROOM



Please scan below QR code to visit our VR showroom.

Veillez scanner ci-dessous QR le code pour visiter notre salle d'exposition VR.

Si prega di scansionare sotto il codice QR per visitare il nostro showroom VR.

Bitte scannen Sie den folgenden QR-Code, um unseren VR-Showroom zu besuchen.

Tel: +86-754-83936189 +86-754-83936991
+86-754-83936290 +86-754-83936992
+86-754-83936223 +86-754-83936266
Fax: +86-754-83936238
Postal Code: 515021
E-mail: info@daya.cc
Website: www.daya.cc

Social Media:       | @Daya Bath

Tel: +86-754-83936189 +86-754-83936991
+86-754-83936290 +86-754-83936992
+86-754-83936223 +86-754-83936266
Fax: +86-754-83936238
Code postal: 515021
E-mail: info@daya.cc
Site web: www.daya.cc

Médias Sociaux:       | @Daya Bath

Tel: +86-754-83936189 +86-754-83936991
+86-754-83936290 +86-754-83936992
+86-754-83936223 +86-754-83936266
Fax: +86-754-83936238
Codice postale: 515021
E-mail: info@daya.cc
Sito web: www.daya.cc

Social Media:       | @Daya Bath

Tel: +86-754-83936189 +86-754-83936991
+86-754-83936290 +86-754-83936992
+86-754-83936223 +86-754-83936266
Fax: +86-754-83936238
PLZ: 515021
E-mail: info@daya.cc
Webseite: www.daya.cc

Soziale Medien:       | @Daya Bath

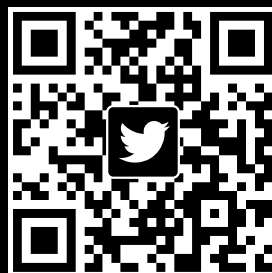

www.showertray.com

www.daya.cc dayabath.en.alibaba.com
daya.en.alibaba.com dayasaniware.en.alibaba.com